

DUAL MONOSTABLE MULTIVIBRATOR WITH SCHMITT-TRIGGER INPUTS

Check for Samples: [SN74LV221A-Q1](#)

FEATURES

- Qualified for Automotive Applications
- 2-V to 5.5-V V_{CC} Operation
- Supports Mixed-Mode Voltage Operation on All Ports
- Schmitt-Trigger Circuitry on \overline{A} , B, and \overline{CLR} Inputs for Slow Transition Rates
- Overriding Clear Terminates Output Pulse
- Glitch-Free Power-Up Reset on Outputs
- I_{off} Supports Partial-Power-Down Mode Operation

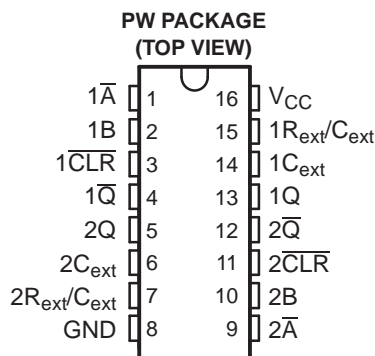

DESCRIPTION/ORDERING INFORMATION

The SN74LV221A is a dual multivibrator designed for 2-V to 5.5-V V_{CC} operation. Each multivibrator has a negative-transition-triggered (\overline{A}) input and a positive-transition-triggered (B) input, either of which can be used as an inhibit input.

This edge-triggered multivibrator features output pulse-duration control by three methods. In the first method, the \overline{A} input is low and the B input goes high. In the second method, the B input is high and the A input goes low. In the third method, the \overline{A} input is low, the B input is high, and the clear (CLR) input goes high.

The output pulse duration is programmable by selecting external resistance and capacitance values. The external timing capacitor must be connected between C_{ext} and R_{ext}/C_{ext} (positive) and an external resistor connected between R_{ext}/C_{ext} and V_{CC} . To obtain variable pulse durations, connect an external variable resistor between R_{ext}/C_{ext} and V_{CC} . The output pulse duration also can be reduced by taking \overline{CLR} low.

Pulse triggering occurs at a particular voltage level and is not related directly to the transition time of the input pulse. The \overline{A} , B, and \overline{CLR} inputs have Schmitt triggers with sufficient hysteresis to handle slow input transition rates with jitter-free triggering at the outputs.

Once triggered, the outputs are independent of further transitions of the \overline{A} and B inputs and are a function of the timing components, or the output pulses can be terminated by the overriding clear. Input pulses can be of any duration relative to the output pulse. Output pulse duration can be varied by choosing the appropriate timing components. Output rise and fall times are TTL compatible and independent of pulse duration. Typical triggering and clearing sequences are illustrated in the input/output timing diagram.

The variance in output pulse duration from device to device typically is less than $\pm 0.5\%$ for given external timing components. An example of this distribution for the SN74LV221A-Q1 is shown in Figure 8. Variations in output pulse duration versus supply voltage and temperature are shown in Figure 5.

During power up, Q outputs are in the low state, and \overline{Q} outputs are in the high state. The outputs are glitch free, without applying a reset pulse.

This device is fully specified for partial-power-down applications using I_{off} . The I_{off} circuitry disables the outputs, preventing damaging current backflow through the devices when they are powered down.



Please be aware that an important notice concerning availability, standard warranty, and use in critical applications of Texas Instruments semiconductor products and disclaimers thereto appears at the end of this data sheet.

Table 1. ORDERING INFORMATION⁽¹⁾

T _A	PACKAGE ⁽²⁾		ORDERABLE PART NUMBER	TOP-SIDE MARKING
-40°C to 125°C	TSSOP – PW	Reel of 2000	SN74LV221AQPWRQ1	LV221AQ

- (1) For the most current package and ordering information, see the Package Option Addendum at the end of this document, or see the TI web site at www.ti.com.
- (2) Package drawings, thermal data, and symbolization are available at www.ti.com/packaging.

DESCRIPTION/ORDERING INFORMATION (CONTINUED)

Pin assignments are identical to those of the SN74AHC123A and SN74AHCT123A devices, so the SN74LV221A-Q1 can be substituted for those devices not using the retrigger feature.

For additional application information on multivibrators, see the application report *Designing With The SN74AHC123A and SN74AHCT123A*, literature number SCLA014.

**FUNCTION TABLE
(EACH MULTIVIBRATOR)**

INPUTS			OUTPUTS		FUNCTION
$\overline{\text{CLR}}$	$\overline{\text{A}}$	B	Q	$\overline{\text{Q}}$	
L	X	X	L	H	Reset
H	H	X	L	H	Inhibit
H	X	L	L	H	Inhibit
H	L	↑	⌋	⌋	Outputs enabled
H	↓	H	⌋	⌋	Outputs enabled
↑ ⁽¹⁾	L	H	⌋	⌋	Outputs enabled

- (1) This condition is true only if the output of the latch formed by the NAND gate has been conditioned to the logic 1 state prior to $\overline{\text{CLR}}$ going high. This latch is conditioned by taking either $\overline{\text{A}}$ high or B low while $\overline{\text{CLR}}$ is inactive (high).

LOGIC DIAGRAM (POSITIVE LOGIC)

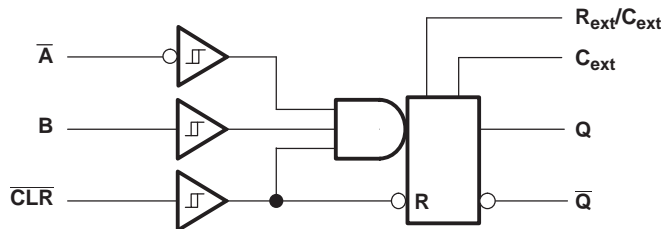

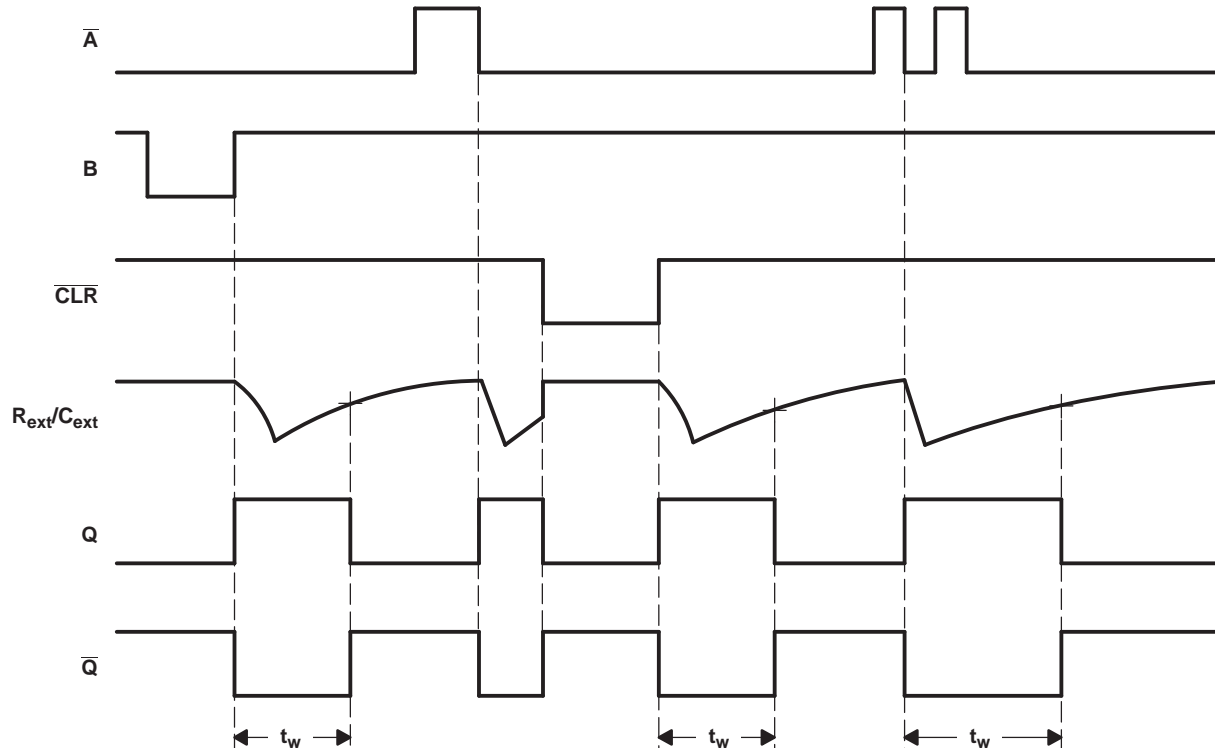
INPUT/OUTPUT TIMING DIAGRAM

Absolute Maximum Ratings⁽¹⁾

over operating free-air temperature (unless otherwise noted)

		MIN	MAX	UNIT
V_{CC}	Supply voltage range	-0.5	7	V
V_I	Input voltage range ⁽²⁾	-0.5	7	V
V_O	Output voltage range in high or low state ^{(2) (3)}	-0.5	$V_{CC} + 0.5$	V
V_O	Output voltage range in power-off state ⁽²⁾	-0.5	7	V
I_{IK}	Input clamp current	$V_I < 0$	-20	mA
I_{OK}	Output clamp current	$V_O < 0$	-50	mA
I_O	Continuous output current	$V_O = 0$ to V_{CC}	± 25	mA
	Continuous current through V_{CC} or GND		± 50	mA
θ_{JA}	Package thermal impedance ⁽⁴⁾		108	$^{\circ}\text{C}/\text{W}$
E_{SD} rating ⁽⁵⁾	Human-Body Model		2 (H2)	kV
	Charged-Device Model		1 (C5)	
	Machine Model		200 (M3)	V
T_{stg}	Storage temperature range	-65	150	$^{\circ}\text{C}$

- (1) Stresses beyond those listed under "absolute maximum ratings" may cause permanent damage to the device. These are stress ratings only, and functional operation of the device at these or any other conditions beyond those indicated under "recommended operating conditions" is not implied. Exposure to absolute-maximum-rated conditions for extended periods may affect device reliability.
- (2) The input and output negative-voltage ratings may be exceeded if the input and output current ratings are observed.
- (3) This value is limited to 5.5 V maximum.
- (4) The package thermal impedance is calculated in accordance with JESD 51-7.
- (5) ESD protection level per AEC Q100 classification

Recommended Operating Conditions⁽¹⁾

		–40°C to 125°C		–40°C to 85°C		UNIT
		MIN	MAX	MIN	MAX	
V _{CC}	Supply voltage	2	5.5	2	5.5	V
V _{IH}	High-level input voltage	V _{CC} = 2 V	1.5	1.5		V
		V _{CC} = 2.3 V to 2.7 V	V _{CC} × 0.7	V _{CC} × 0.7		
		V _{CC} = 3 V to 3.6 V	V _{CC} × 0.7	V _{CC} × 0.7		
		V _{CC} = 4.5 V to 5.5 V	V _{CC} × 0.7	V _{CC} × 0.7		
V _{IL}	Low-level input voltage	V _{CC} = 2 V	0.5	0.5		V
		V _{CC} = 2.3 V to 2.7 V	V _{CC} × 0.3	V _{CC} × 0.3		
		V _{CC} = 3 V to 3.6 V	V _{CC} × 0.3	V _{CC} × 0.3		
		V _{CC} = 4.5 V to 5.5 V	V _{CC} × 0.3	V _{CC} × 0.3		
V _I	Input voltage	0	5.5	0	5.5	V
V _O	Output voltage	0	V _{CC}	0	V _{CC}	V
I _{OH}	High-level output current	V _{CC} = 2 V	–50	–50		μA
		V _{CC} = 2.3 V to 2.7 V	–2	–2		mA
		V _{CC} = 3 V to 3.6 V	–6	–6		
		V _{CC} = 4.5 V to 5.5 V	–12	–12		
I _{OL}	Low-level output current	V _{CC} = 2 V	50	50		μA
		V _{CC} = 2.3 V to 2.7 V	2	2		mA
		V _{CC} = 3 V to 3.6 V	6	6		
		V _{CC} = 4.5 V to 5.5 V	12	12		
R _{ext}	External timing resistance	V _{CC} = 2 V	5k	5k		Ω
		V _{CC} ≥ 3 V	1k	1k		
C _{ext}	External timing capacitance	No restriction		No restriction		pF
Δt/ΔV _{CC}	Power-up ramp rate	1		1		ms/V
T _A	Operating free-air temperature	–40	125	–40	85	°C

(1) All unused inputs of the device must be held at V_{CC} or GND to ensure proper device operation. Refer to the TI application report, *Implications of Slow or Floating CMOS Inputs*, literature number SCBA004.

Electrical Characteristics

over recommended operating free-air temperature range (unless otherwise noted)

PARAMETER	TEST CONDITIONS	V _{CC}	–40°C to 125°C			–40°C to 85°C			UNIT
			MIN	TYP	MAX	MIN	TYP	MAX	
V _{OH}	I _{OH} = –50 μA	2 V to 5.5 V	V _{CC} – 0.1			V _{CC} – 0.1			V
	I _{OH} = –2 mA	2.3 V	2			2			
	I _{OH} = –6 mA	3 V	2.48			2.48			
	I _{OH} = –12 mA	4.5 V	3.8			3.8			
V _{OL}	I _{OL} = 50 μA	2 V to 5.5 V	0.1			0.1			V
	I _{OL} = 2 mA	2.3 V	0.4			0.4			
	I _{OL} = 6 mA	3 V	0.44			0.44			
	I _{OL} = 12 mA	4.5 V	0.55			0.55			
I _I	\bar{A} , B ₁ and CLR V _I = 5.5 V or GND	0	±1			±1			μA
		0 to 5.5 V	±1			±1			
I _{CC}	Quiescent	V _I = V _{CC} or GND, I _O = 0	5.5 V			20			μA
I _{CC}	Active state (per circuit)	V _I = V _{CC} or GND, R _{ext} /C _{ext} = 0.5 V _{CC}	3 V			280			μA
			4.5 V			650			
			5.5 V			975			
I _{off}		V _I or V _O = 0 to 5.5 V	0			10			μA
C _i		V _I = V _{CC} or GND	3.3 V			1.9			pF
			5 V			1.9			

Timing Requirements

 over recommended operating free-air temperature range, V_{CC} = 3.3 V ± 0.3 V (unless otherwise noted) (see [Figure 1](#))

		T _A = 25°C		–40°C to 125°C		–40°C to 85°C		UNIT
		MIN	MAX	MIN	MAX	MIN	MAX	
t _w	Pulse duration	CLR		5		7		ns
		\bar{A} or B trigger		5		7		

Timing Requirements

 over recommended operating free-air temperature range, V_{CC} = 5 V ± 0.5 V (unless otherwise noted) (see [Figure 1](#))

		T _A = 25°C		–40°C to 125°C		–40°C to 85°C		UNIT
		MIN	MAX	MIN	MAX	MIN	MAX	
t _w	Pulse duration	CLR		5		7		ns
		\bar{A} or B trigger		5		7		

Switching Characteristics

over recommended operating free-air temperature range, $V_{CC} = 3.3 \text{ V} \pm 0.3 \text{ V}$ (unless otherwise noted) (see [Figure 1](#))

PARAMETER	FROM (INPUT)	TO (OUTPUT)	LOAD CAPACITANCE	$T_A = 25^\circ\text{C}$			$-40^\circ\text{C to } 125^\circ\text{C}$		$-40^\circ\text{C to } 85^\circ\text{C}$		UNIT
				MIN	TYP	MAX	MIN	MAX	MIN	MAX	
t_{pd}	\bar{A} or B	Q or \bar{Q}	$C_L = 50 \text{ pF}$	11.8	24.1		1	30.5	1	27.5	ns
	\bar{CLR}			10.6	19.3		1	25	1	22	
	\bar{CLR} trigger			12.3	25.9		1	32.5	1	29.5	
$t_w^{(1)}$		Q or \bar{Q}	$C_L = 50 \text{ pF}$, $C_{ext} = 28 \text{ pF}$, $R_{ext} = 2 \text{ k}\Omega$	186	240			340		300	ns
			$C_L = 50 \text{ pF}$, $C_{ext} = 0.01 \mu\text{F}$, $R_{ext} = 10 \text{ k}\Omega$	90	100	110	85	115	90	110	μs
			$C_L = 50 \text{ pF}$, $C_{ext} = 0.1 \text{ pF}$, $R_{ext} = 10 \text{ k}\Omega$	0.9	1	1.1	0.85	1.15	0.9	1.1	ms
$\Delta t_w^{(2)}$			$C_L = 50 \text{ pF}$	± 1							%

(1) t_w = Pulse duration at Q and \bar{Q} outputs

(2) Δt_w = Output pulse-duration variation (Q and \bar{Q}) between circuits in same package

Switching Characteristics

over recommended operating free-air temperature range, $V_{CC} = 5 \text{ V} \pm 0.5 \text{ V}$ (unless otherwise noted) (see [Figure 1](#))

PARAMETER	FROM (INPUT)	TO (OUTPUT)	LOAD CAPACITANCE	$T_A = 25^\circ\text{C}$			$-40^\circ\text{C to } 125^\circ\text{C}$		$-40^\circ\text{C to } 85^\circ\text{C}$		UNIT
				MIN	TYP	MAX	MIN	MAX	MIN	MAX	
t_{pd}	\bar{A} or B	Q or \bar{Q}	$C_L = 50 \text{ pF}$	8.2	14		1	19	1	16	ns
	\bar{CLR}			7.4	11.4		1	16	1	13	
	\bar{CLR} trigger			8.6	14.9		1	20	1	17	
$t_w^{(1)}$		Q or \bar{Q}	$C_L = 50 \text{ pF}$, $C_{ext} = 28 \text{ pF}$, $R_{ext} = 2 \text{ k}\Omega$	171	200			280		240	ns
			$C_L = 50 \text{ pF}$, $C_{ext} = 0.01 \mu\text{F}$, $R_{ext} = 10 \text{ k}\Omega$	90	100	110	85	115	90	110	μs
			$C_L = 50 \text{ pF}$, $C_{ext} = 0.1 \text{ pF}$, $R_{ext} = 10 \text{ k}\Omega$	0.9	1	1.1	0.85	1.15	0.9	1.1	ms
$\Delta t_w^{(2)}$			$C_L = 50 \text{ pF}$	± 1							%

(1) t_w = Pulse duration at Q and \bar{Q} outputs

(2) Δt_w = Output pulse-duration variation (Q and \bar{Q}) between circuits in same package

Operating Characteristics

$T_A = 25^\circ\text{C}$

PARAMETER		TEST CONDITIONS	V_{CC}	TYP	UNIT
C_{pd}	Power dissipation capacitance	$C_L = 50 \text{ pF}$, $f = 10 \text{ MHz}$	3.3 V	50	pF
			5 V	51	

PARAMETER MEASUREMENT INFORMATION

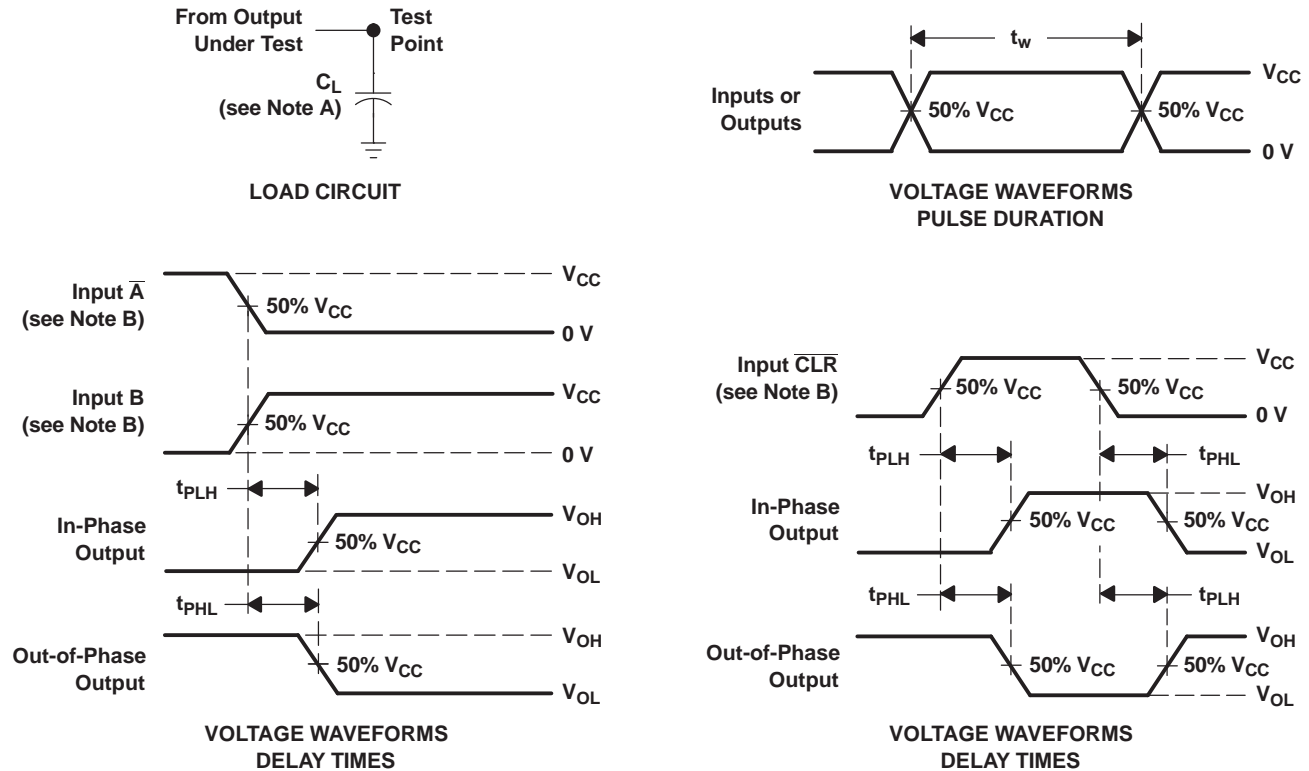

- NOTES: A. C_L includes probe and jig capacitance.
 B. All input pulses are supplied by generators having the following characteristics: $PRR \leq 1\text{ MHz}$, $Z_O = 50\ \Omega$, $t_r = 3\text{ ns}$, $t_f = 3\text{ ns}$.
 C. The outputs are measured one at a time, with one input transition per measurement.

Figure 1. Load Circuit and Voltage Waveforms

APPLICATION INFORMATION

Caution in Use

To prevent malfunctions due to noise, connect a high-frequency capacitor between V_{CC} and GND, and keep the wiring between the external components and C_{ext} and R_{ext}/C_{ext} terminals as short as possible.

Power-Down Considerations

Large values of C_{ext} can cause problems when powering down the SN74LV221A-Q1 because of the amount of energy stored in the capacitor. When a system containing this device is powered down, the capacitor can discharge from V_{CC} through the protection diodes at pin 2 or pin 14. Current through the input protection diodes must be limited to 30 mA; therefore, the turn-off time of the V_{CC} power supply must not be faster than $t = V_{CC} \times C_{ext}/30 \text{ mA}$. For example, if $V_{CC} = 5 \text{ V}$ and $C_{ext} = 15 \text{ pF}$, the V_{CC} supply must turn off no faster than $t = (5 \text{ V}) \times (15 \text{ pF})/30 \text{ mA} = 2.5 \text{ ns}$. Usually, this is not a problem because power supplies are heavily filtered and cannot discharge at this rate. When a more rapid decrease of V_{CC} to zero occurs, the SN74LV221A-Q1 can sustain damage. To avoid this possibility, use external clamping diodes.

Output Pulse Duration

The output pulse duration, t_w , is determined primarily by the values of the external capacitance (C_T) and timing resistance (R_T). The timing components are connected as shown in [Figure 2](#).

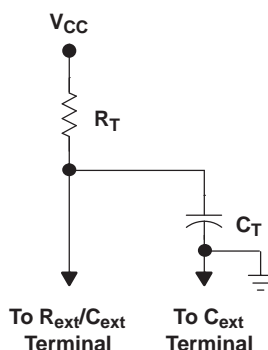

Figure 2. Timing-Component Connections

The pulse duration is given by:

$$t_w = K \times R_T \times C_T$$

if C_T is $\geq 1000 \text{ pF}$, $K = 1.0$

or

if C_T is $< 1000 \text{ pF}$, K can be determined from [Figure 7](#)

where:

t_w = pulse duration in ns

R_T = external timing resistance in $k\Omega$

C_T = external capacitance in pF

K = multiplier factor

(1)

[Equation 1](#) and [Figure 3](#) or [Figure 4](#) can be used to determine values for pulse duration, external resistance, and external capacitance.

APPLICATION INFORMATION

Operation of the device at these or any other conditions beyond those indicated under "recommended operating conditions" is not implied.

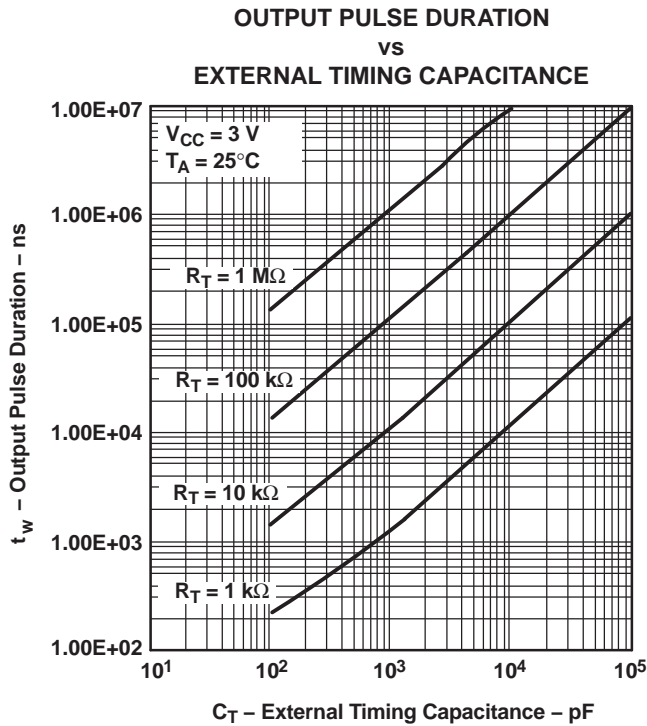

Figure 3.

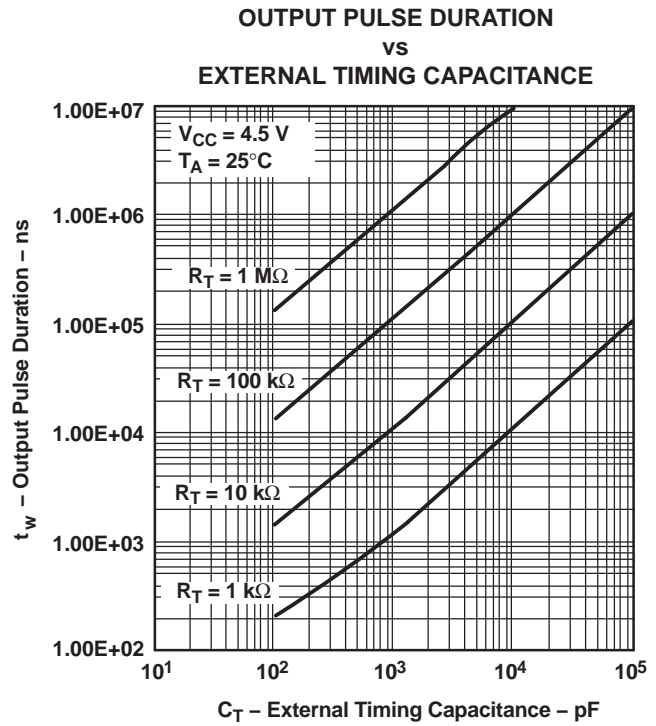

Figure 4.

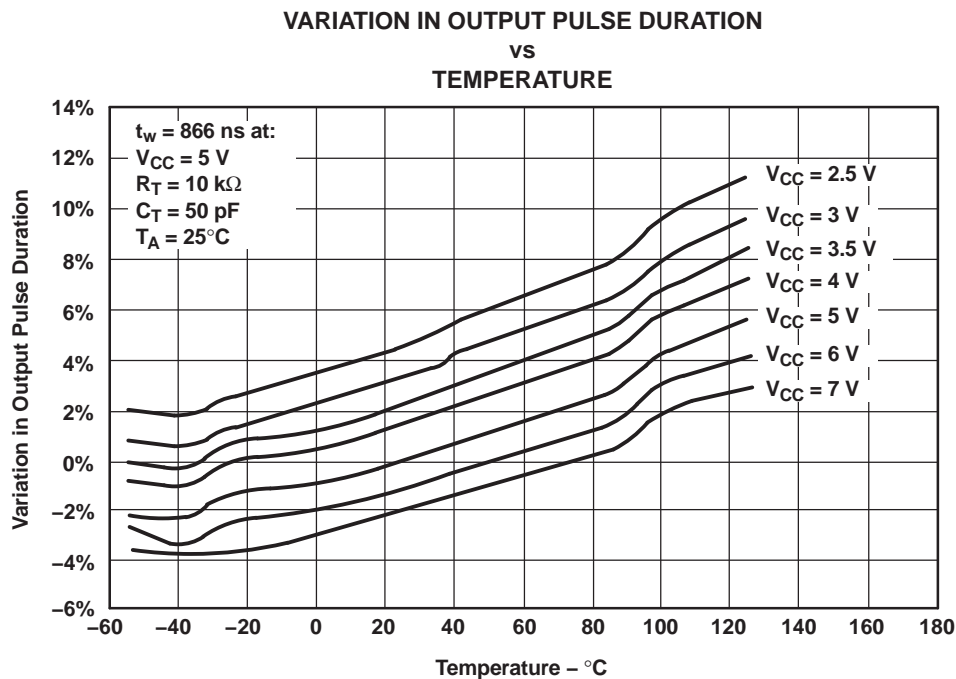

Figure 5.

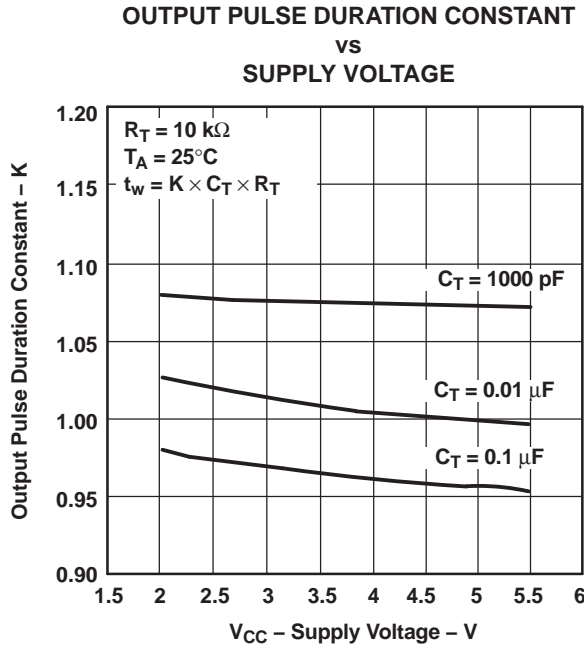

Figure 6.

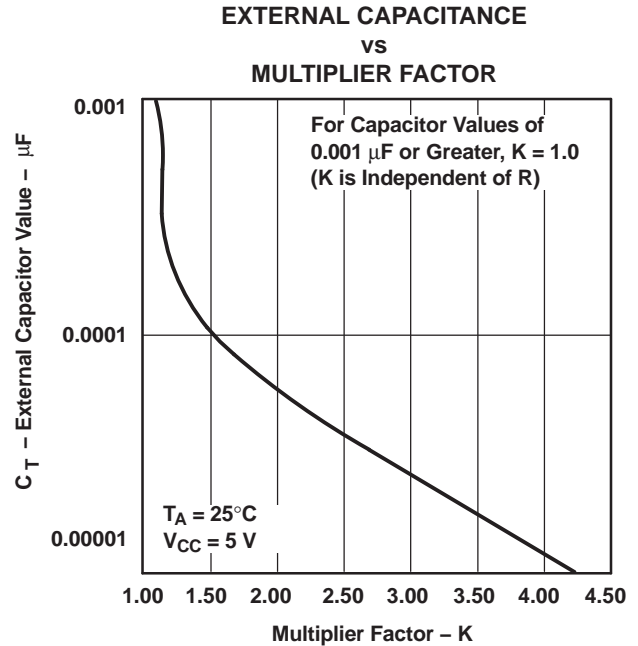

Figure 7.

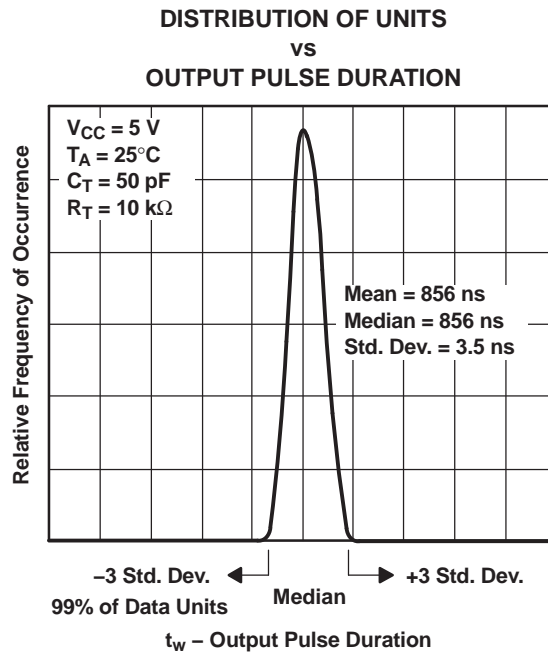

Figure 8.

PACKAGING INFORMATION

Orderable Device	Status ⁽¹⁾	Package Type	Package Drawing	Pins	Package Qty	Eco Plan ⁽²⁾	Lead/Ball Finish	MSL Peak Temp ⁽³⁾
SN74LV221AQPWRG4Q1	ACTIVE	TSSOP	PW	16	2000	Green (RoHS & no Sb/Br)	CU NIPDAU	Level-1-260C-UNLIM
SN74LV221AQPWRQ1	ACTIVE	TSSOP	PW	16	2000	Green (RoHS & no Sb/Br)	CU NIPDAU	Level-3-260C-168 HR

⁽¹⁾ The marketing status values are defined as follows:

ACTIVE: Product device recommended for new designs.

LIFEBUY: TI has announced that the device will be discontinued, and a lifetime-buy period is in effect.

NRND: Not recommended for new designs. Device is in production to support existing customers, but TI does not recommend using this part in a new design.

PREVIEW: Device has been announced but is not in production. Samples may or may not be available.

OBsolete: TI has discontinued the production of the device.

⁽²⁾ Eco Plan - The planned eco-friendly classification: Pb-Free (RoHS), Pb-Free (RoHS Exempt), or Green (RoHS & no Sb/Br) - please check <http://www.ti.com/productcontent> for the latest availability information and additional product content details.

TBD: The Pb-Free/Green conversion plan has not been defined.

Pb-Free (RoHS): TI's terms "Lead-Free" or "Pb-Free" mean semiconductor products that are compatible with the current RoHS requirements for all 6 substances, including the requirement that lead not exceed 0.1% by weight in homogeneous materials. Where designed to be soldered at high temperatures, TI Pb-Free products are suitable for use in specified lead-free processes.

Pb-Free (RoHS Exempt): This component has a RoHS exemption for either 1) lead-based flip-chip solder bumps used between the die and package, or 2) lead-based die adhesive used between the die and leadframe. The component is otherwise considered Pb-Free (RoHS compatible) as defined above.

Green (RoHS & no Sb/Br): TI defines "Green" to mean Pb-Free (RoHS compatible), and free of Bromine (Br) and Antimony (Sb) based flame retardants (Br or Sb do not exceed 0.1% by weight in homogeneous material)

⁽³⁾ MSL, Peak Temp. -- The Moisture Sensitivity Level rating according to the JEDEC industry standard classifications, and peak solder temperature.

Important Information and Disclaimer: The information provided on this page represents TI's knowledge and belief as of the date that it is provided. TI bases its knowledge and belief on information provided by third parties, and makes no representation or warranty as to the accuracy of such information. Efforts are underway to better integrate information from third parties. TI has taken and continues to take reasonable steps to provide representative and accurate information but may not have conducted destructive testing or chemical analysis on incoming materials and chemicals. TI and TI suppliers consider certain information to be proprietary, and thus CAS numbers and other limited information may not be available for release.

In no event shall TI's liability arising out of such information exceed the total purchase price of the TI part(s) at issue in this document sold by TI to Customer on an annual basis.

OTHER QUALIFIED VERSIONS OF SN74LV221A-Q1 :

- Catalog: [SN74LV221A](#)

NOTE: Qualified Version Definitions:

- Catalog - TI's standard catalog product

PW (R-PDSO-G16)

PLASTIC SMALL OUTLINE



4040064-4/G 02/11

- NOTES:
- A. All linear dimensions are in millimeters. Dimensioning and tolerancing per ASME Y14.5M-1994.
 - B. This drawing is subject to change without notice.
 - C. Body length does not include mold flash, protrusions, or gate burrs. Mold flash, protrusions, or gate burrs shall not exceed 0,15 each side.
 - D. Body width does not include interlead flash. Interlead flash shall not exceed 0,25 each side.
 - E. Falls within JEDEC MO-153

PW (R-PDSO-G16)

PLASTIC SMALL OUTLINE

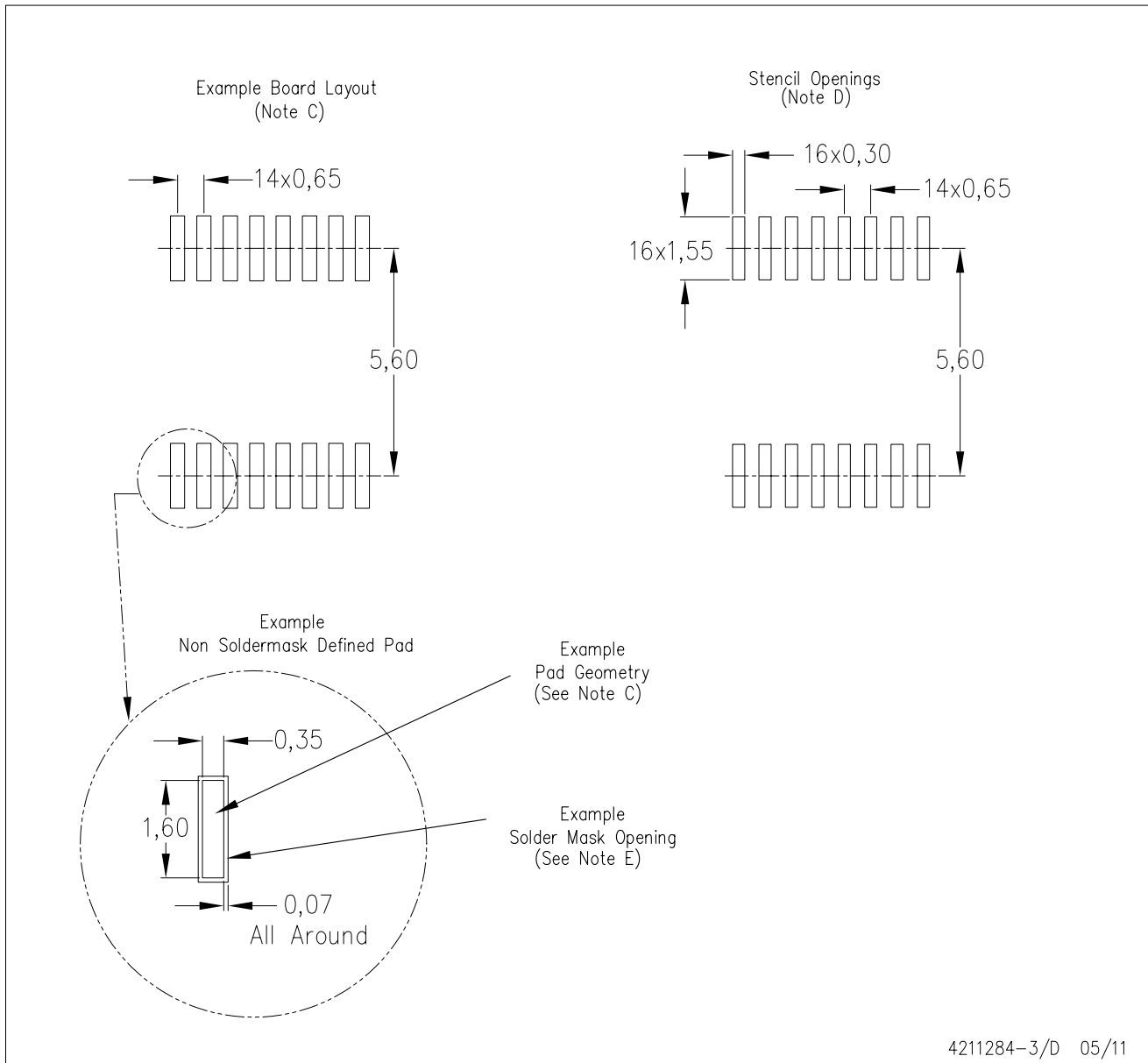

- NOTES:
- All linear dimensions are in millimeters.
 - This drawing is subject to change without notice.
 - Publication IPC-7351 is recommended for alternate designs.
 - Laser cutting apertures with trapezoidal walls and also rounding corners will offer better paste release. Customers should contact their board assembly site for stencil design recommendations. Refer to IPC-7525 for other stencil recommendations.
 - Customers should contact their board fabrication site for solder mask tolerances between and around signal pads.

IMPORTANT NOTICE

Texas Instruments Incorporated and its subsidiaries (TI) reserve the right to make corrections, modifications, enhancements, improvements, and other changes to its products and services at any time and to discontinue any product or service without notice. Customers should obtain the latest relevant information before placing orders and should verify that such information is current and complete. All products are sold subject to TI's terms and conditions of sale supplied at the time of order acknowledgment.

TI warrants performance of its hardware products to the specifications applicable at the time of sale in accordance with TI's standard warranty. Testing and other quality control techniques are used to the extent TI deems necessary to support this warranty. Except where mandated by government requirements, testing of all parameters of each product is not necessarily performed.

TI assumes no liability for applications assistance or customer product design. Customers are responsible for their products and applications using TI components. To minimize the risks associated with customer products and applications, customers should provide adequate design and operating safeguards.

TI does not warrant or represent that any license, either express or implied, is granted under any TI patent right, copyright, mask work right, or other TI intellectual property right relating to any combination, machine, or process in which TI products or services are used. Information published by TI regarding third-party products or services does not constitute a license from TI to use such products or services or a warranty or endorsement thereof. Use of such information may require a license from a third party under the patents or other intellectual property of the third party, or a license from TI under the patents or other intellectual property of TI.

Reproduction of TI information in TI data books or data sheets is permissible only if reproduction is without alteration and is accompanied by all associated warranties, conditions, limitations, and notices. Reproduction of this information with alteration is an unfair and deceptive business practice. TI is not responsible or liable for such altered documentation. Information of third parties may be subject to additional restrictions.

Resale of TI products or services with statements different from or beyond the parameters stated by TI for that product or service voids all express and any implied warranties for the associated TI product or service and is an unfair and deceptive business practice. TI is not responsible or liable for any such statements.

TI products are not authorized for use in safety-critical applications (such as life support) where a failure of the TI product would reasonably be expected to cause severe personal injury or death, unless officers of the parties have executed an agreement specifically governing such use. Buyers represent that they have all necessary expertise in the safety and regulatory ramifications of their applications, and acknowledge and agree that they are solely responsible for all legal, regulatory and safety-related requirements concerning their products and any use of TI products in such safety-critical applications, notwithstanding any applications-related information or support that may be provided by TI. Further, Buyers must fully indemnify TI and its representatives against any damages arising out of the use of TI products in such safety-critical applications.

TI products are neither designed nor intended for use in military/aerospace applications or environments unless the TI products are specifically designated by TI as military-grade or "enhanced plastic." Only products designated by TI as military-grade meet military specifications. Buyers acknowledge and agree that any such use of TI products which TI has not designated as military-grade is solely at the Buyer's risk, and that they are solely responsible for compliance with all legal and regulatory requirements in connection with such use.

TI products are neither designed nor intended for use in automotive applications or environments unless the specific TI products are designated by TI as compliant with ISO/TS 16949 requirements. Buyers acknowledge and agree that, if they use any non-designated products in automotive applications, TI will not be responsible for any failure to meet such requirements.

Following are URLs where you can obtain information on other Texas Instruments products and application solutions:

Products

Audio	www.ti.com/audio
Amplifiers	amplifier.ti.com
Data Converters	dataconverter.ti.com
DLP® Products	www.dlp.com
DSP	dsp.ti.com
Clocks and Timers	www.ti.com/clocks
Interface	interface.ti.com
Logic	logic.ti.com
Power Mgmt	power.ti.com
Microcontrollers	microcontroller.ti.com
RFID	www.ti-rfid.com
RF/IF and ZigBee® Solutions	www.ti.com/lprf

Applications

Communications and Telecom	www.ti.com/communications
Computers and Peripherals	www.ti.com/computers
Consumer Electronics	www.ti.com/consumer-apps
Energy and Lighting	www.ti.com/energy
Industrial	www.ti.com/industrial
Medical	www.ti.com/medical
Security	www.ti.com/security
Space, Avionics and Defense	www.ti.com/space-avionics-defense
Transportation and Automotive	www.ti.com/automotive
Video and Imaging	www.ti.com/video
Wireless	www.ti.com/wireless-apps

TI E2E Community Home Page

e2e.ti.com

Mailing Address: Texas Instruments, Post Office Box 655303, Dallas, Texas 75265
Copyright © 2011, Texas Instruments Incorporated