

# Linear Regulator Controller

## FEATURES

- **Low Dropout Voltage:**  
100 mV @ 650 mA with FZT749 PNP Transistor
- **Output Voltage:** 2V to 6V in 0.1V Increments
- **2.7V to 8V Supply Range**
- **Low Operating Current:** .....  
50  $\mu$ A Operating; 0.2  $\mu$ A Shutdown
- **Low-True Chip Enable**
- **Output Accuracy** <  $\pm$ 2%
- **Small Package:** 5-Pin SOT-23A

## TYPICAL APPLICATIONS

- **Battery Operated Systems**
- **Portable Instruments**
- **High-Efficiency Linear Regulator**
- **Post-Regulator for SMPS**
- **Power Supply or Battery Back-Up Supply for Memory**

### TYPICAL APPLICATION

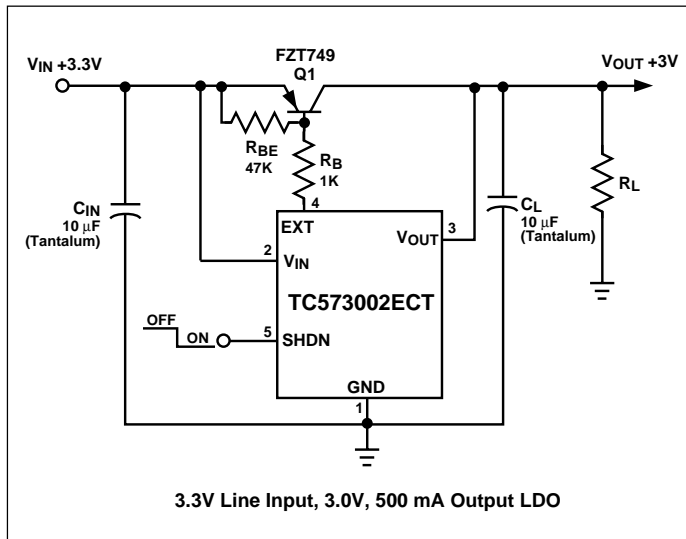

## GENERAL DESCRIPTION

The TC57 is a low dropout regulator controller that operates with an external PNP pass transistor, allowing the user to tailor the LDO characteristics to suit the application at hand. This results in lower dropout operation (and often lower cost) compared with traditional linear regulators with on-board pass transistors. The maximum output current of a TC57-based regulator circuit is limited only by the characteristics of the external pass transistor. For example, a maximum output current of 650 mA (with a dropout voltage of 100 mV) results when an FZT749 pass transistor is used, while a Darlington configuration can deliver up to 4A.

Flexibility, and superior performance make this family of regulator controllers the ideal choice in applications where low dropout voltage and low installed cost are key.

## ORDERING INFORMATION

**PART CODE TC57 XX 02 ECT XX**

- Output Voltage:** \_\_\_\_\_  
Ex: 30 = 3.0V
- Tolerance:** \_\_\_\_\_  
2 =  $\pm$ 2%
- Temperature/Package:** \_\_\_\_\_  
E: -40°C to +85°C  
CT: 5-Pin SOT-23A
- Taping Direction:** \_\_\_\_\_  
TR: Standard Taping  
RT: Reverse Taping

## PIN CONFIGURATION

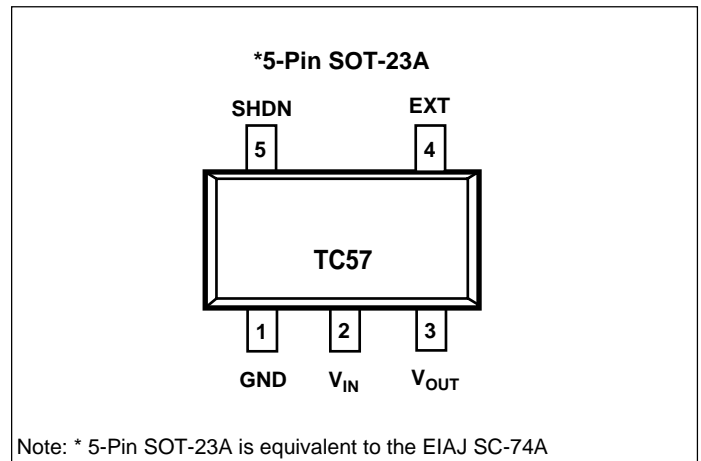

## TC57 Series

### ABSOLUTE MAXIMUM RATINGS\*

Voltage on $V_{IN}$ and EXT Pins .....	+12V
Voltage on $V_{OUT}$ and SHDN Pins .....	-0.3V to ( $V_{IN} + 0.3V$ )
EXT Pin Current .....	50 mA
Operating Temperature Range ( $T_C$ ) .....	-40°C to +85°C
Storage Temperature ( $T_{STG}$ ) .....	-40°C to +150°C
Power Dissipation .....	150 mW

\*Static-sensitive device. Unused devices must be stored in conductive material. Protect devices from static discharge and static fields. Stresses above those listed under Absolute Maximum Ratings may cause permanent damage to the device. These are stress ratings only and functional operation of the device at these or any other conditions above those indicated in the operational sections of the specifications is not implied. Exposure to Absolute Maximum Rating Conditions for extended periods may affect device reliability.

### ELECTRICAL CHARACTERISTICS TC57EP3002 (NOTE 2): (SHDN = GND, $V_{IN} = V_{OUT} + 1V$ , $V_{OUT} = 3V$ to 5V, $I_{OUT} = 0$ , $T_A = 25^\circ C$ , Test Circuit of Figure 1, unless otherwise noted.)

Symbol	Parameter	Test Conditions	Min	Typ	Max	Unit
$V_{IN}$	Input Voltage		—	—	8	V
$V_{EXT}$	Voltage on EXT Output		—	—	8	V
$V_{OUT}$	Output Voltage	$I_{OUT} = 50$ mA (Note 1)	$0.98 \times V_R$	$V_R \pm 0.5\%$	$1.02 \times V_R$	V
$\Delta V_{OUT}$	Load Regulation	$1$ mA $\leq I_{OUT} \leq 100$ mA (Note 3)	-60	—	60	mV
$V_{IN} - V_{OUT}$	Dropout Voltage (Note 2)	$I_{OUT} = 100$ mA	—	100	—	mV
$I_{DD}$	Supply Current	$V_{SHDN} = V_{IN} = 5V$	—	50	80	$\mu A$
$I_{SHDN}$	Shutdown Supply Current	$V_{SHDN} = GND$	—	—	0.6	$\mu A$
$\Delta V_{OUT}/\Delta V_{IN}$	Line Regulation	$I_{OUT} = 50$ mA, $4V \leq V_{IN} \leq 8V$ (Note 3)	—	0.1	0.3	%/V
$\Delta V_{OUT}/\Delta T$	$V_{OUT}$ Temp. Coefficient	$I_{OUT} = 10$ mA, $-40^\circ C < T_J < +85^\circ C$ (Note 3)	—	$\pm 100$	—	ppm/ $^\circ C$
$I_{LEXT}$	EXT Pin Leakage Current		—	—	0.5	$\mu A$
$I_{EXT}$	EXT Sink Current	(Note 4)	—	—	25	mA
$V_{IH}$	SHDN Input High Logic Threshold		1.5	—	—	V
$V_{IL}$	SHDN Input Low Logic Threshold		—	—	0.25	V
$I_{IH}$	SHDN Input Current @ $V_{IH}$	$V_{SHDN} = V_{IN} = 5V$	—	—	0.1	$\mu A$
$I_{IL}$	SHDN Input Current @ $V_{IL}$	$V_{SHDN} = GND$	-0.2	-0.05	0	$\mu A$

- NOTES:**
- $V_R$  is the regulator output voltage setting.
  - Dropout voltage is defined as the input to output differential at which the output voltage drops 2% below its nominal value measured at a 1V differential.
  - Varies with type of pass transistor used. Numbers shown are for the test circuit of Figure 1.
  - The product of  $I_{EXT} \times V_{EXT}$  must be less than the maximum allowable power dissipation.

### PIN DESCRIPTION

Pin Number	Name	Description
1	GND	Ground Terminal.
2	V <sub>IN</sub>	Supply Voltage Input. Positive input voltage of 2.7V to 8.0V.
3	V <sub>OUT</sub>	Regulator Voltage Sense Input. Connects to the collector of the external PNP pass transistor.
4	EXT	Base Drive for the external PNP pass transistor.
5	SHDN	Shutdown Input. The device is enabled when SHDN ≤ V <sub>IL</sub> . The device enters a low power shutdown state when SHDN ≥ V <sub>IH</sub> . During shutdown, the output is disabled, and supply current falls to less than 1 μA.

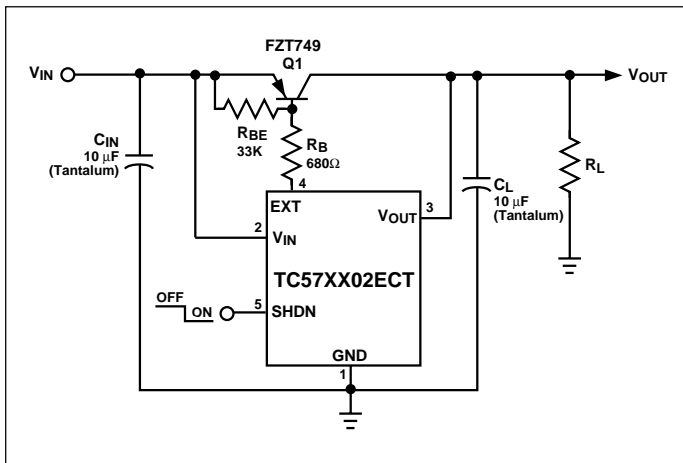

Figure 1. Test Circuit

## TC57 Series

### DETAILED DESCRIPTION

The TC57 series of precision low dropout regulator controllers use an external PNP transistor to accommodate a wide range of output currents. A series resistor ( $R_B$ ) limits the maximum base current drawn from the PNP transistor. Limiting the base drive both determines the regulator's output current capability, as well as limits ground current when the device is operated in dropout. The PNP transistor's  $V_{CE(SAT)}$  is the only factor limiting dropout voltage.

### Transistor Selection

The PNP pass transistor must have satisfactory power dissipation, current gain, and collector current specifications to suit the application at hand. The maximum output current the circuit can deliver is influenced by  $h_{FE}$ . The highest guaranteed output current is given by:

$$I_{LOAD(MAX)} = 25 \text{ mA} \times h_{FE(MIN)}$$

Equation 1.

The transistor's actual power dissipation (PD) is equal to the maximum load current times the maximum input/output voltage differential, or:

$$P_D = I_{LOAD(MAX)} \times (V_{IN(MAX)} - V_{OUT(min)})$$

Equation 2.

The ideal transistor has a minimum  $h_{FE}$  of 100, and a  $V_{CE(SAT)}$  of less than 0.6V at full output current. For example, the Zetex FZT749 has an  $h_{FE}$  of 170 at a collector current of 1A, and a guaranteed  $V_{CE(SAT)}$  of 0.3V at a base current of 100 mA. It is packaged in a SOT223 and is recommended for use with the TC57. Other transistors are also suitable, depending on the required input and output voltages and output current (Table 2a).

### Base-Current Limiting Resistor (Figure 2)

Base current limiting resistor  $R_B$  can be estimated using:

$$R_B = \frac{h_{FE}(V_{IN} - V_{BE})}{I_{OUT}}$$

Equation 3.

where:  $h_{FE}$  is the current gain of the pass transistor

$V_{IN}$  is the input voltage (in volts)

$V_{BE}$  is the base-emitter voltage at the desired output current (in volts)

$I_{OUT}$  is the output current (in Amps)

For example, assume a desired continuous output current of 1.0A, an input voltage of 5V, and an FZT749 pass transistor. The FZT749 has a typical  $h_{FE}$  of 170, and a  $V_{BE}$  of 0.8V; both specified at a collector current of 1.0A. Substituting these values into the equation above results in an  $R_B$  value of 704 $\Omega$  (closest standard value = 680 $\Omega$ ).

### Pull-Up Resistor and Output Capacitor (Figure 2)

A pull-up resistor ( $R_{BE}$ , installed between the base and emitter of the pass transistor) facilitates rapid turn-off of the pass transistor in the event of a sudden decrease in load. Recommended values for this resistor are between 20 K $\Omega$  and 47 K $\Omega$ . A Tantalum output capacitor of at least 10  $\mu$ F must be used to guarantee stability. Higher values decrease output noise and eliminate power-on overshoot, but extend power-up times. Table 2a lists several capacitor choices.

### Input Capacitor (Figure 2)

The addition of an input capacitor further reduces output noise, and negates the effects of power supply input impedance. A 10  $\mu$ F(min) Tantalum capacitor is recommended.

### Shutdown Mode

The TC57 enters a low power shutdown mode when the shutdown input (SHDN) is high. During shutdown, the regulator is disabled, the output capacitor is discharged through the load, and supply current to the TC57 decreases to less than 1 $\mu$ A. Normal operation resumes when SHDN is brought low. If the shutdown mode is not used, SHDN should be tied to  $V_{IN}$ .

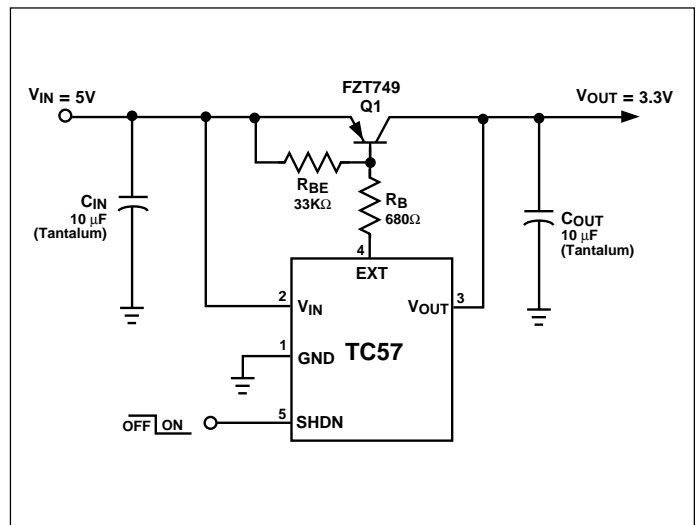

Figure 2. 3.3V, 1A Regulator Using 5V Supply Input

# Linear Regulator Controller

## TC57 Series

**Table 2a. Component Suppliers**

Device	Manufacturer	Product Method
<b>CAPACITORS</b>		
267 Series	Matsuo	Surface Mount
F95 Tantalum Series	Nichicon	Surface Mount
595 Tantalum Series	Sprague	Surface Mount
OS-CON Series	Sanyo	Through-Hole
Low-ESR Organic Semiconductor		
LXF Series	United Chemi-Con	Through-Hole
<b>BIPOLAR TRANSISTORS</b>		
ZTX749	Zetex	Through-Hole
T1P42	Motorola	Through-Hole
2N4403	Motorola	Through-Hole
2N2907A	Motorola	Through-Hole
CMPT2907A	Central Semiconductor	Surface Mount
PZT2907AT1	Motorola	Surface Mount
FZT749	Zetex	Surface Mount

**Table 2b. Manufacturers' Phone and Fax Numbers**

Manufacturer	Country	Telephone	Fax
Central Semiconductor	USA	(516) 435-1110	(516) 435-1824
Matsuo	USA	(714) 969-2491	(714) 960-6492
Motorola	USA	(602) 244-3370	(602) 244-4015
Nichicon	USA Japan	(847) 843-7500 81-7-5231-8461	(847) 843-2798 81-7-5256-4158
Sanyo	USA Japan	(619) 661-6835 81-7-2070-6306	(619) 661-1055 81-7-2070-1174
Sprague	USA	(603) 224-1961	(603) 224-1430
United Chemi-Con	USA	(714) 255-9500	(714) 255-9400
Zetex	USA UK	(516) 543-7100 44-61-627-5105	(516) 864-7630 44-61-627-5467

### MARKINGS

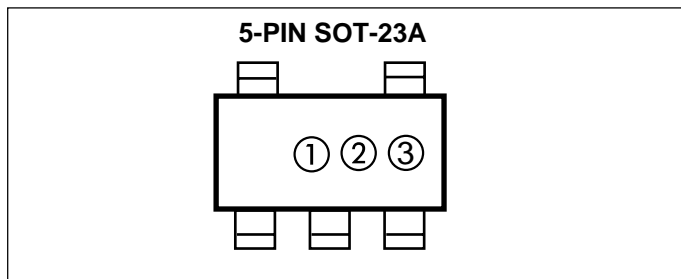

① represents integer part of output voltage

Symbol	Voltage
2	2.
3	3.
4	4.
5	5.
6	6.

② represents 1st decimal of output voltage

Symbol	Voltage	Symbol	Voltage
0	.0	5	.5
1	.1	6	.6
2	.2	7	.7
3	.3	8	.8
4	.4	9	.9

③ represents production lot ID code

## TC57 Series

### TYPICAL CHARACTERISTICS CURVES

#### 1. OUTPUT VOLTAGE vs. OUTPUT CURRENT

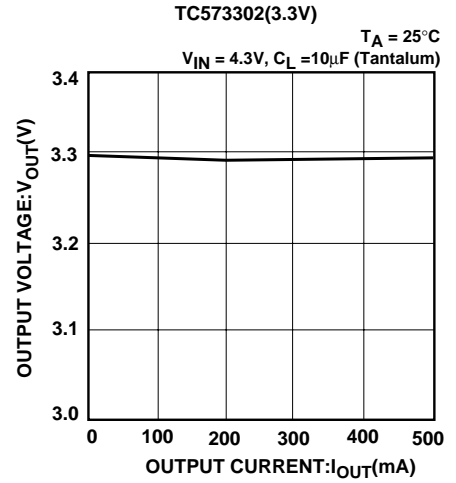
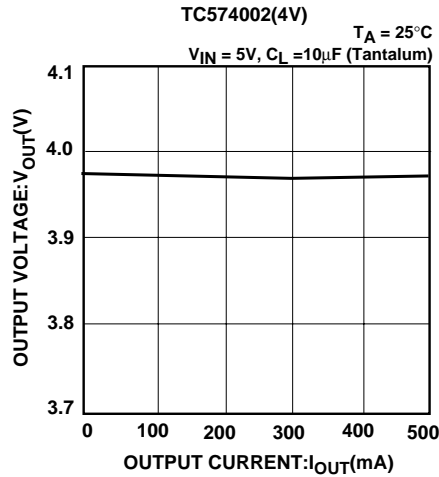
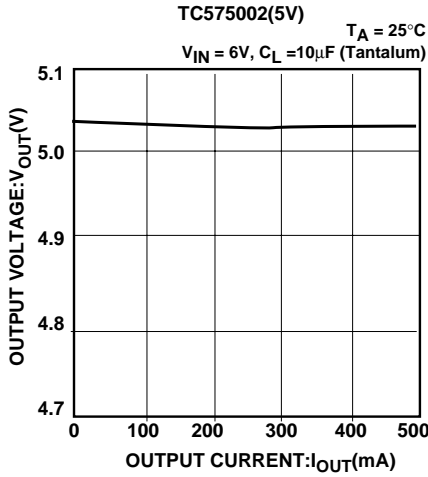

#### 2. OUTPUT VOLTAGE vs. INPUT VOLTAGE

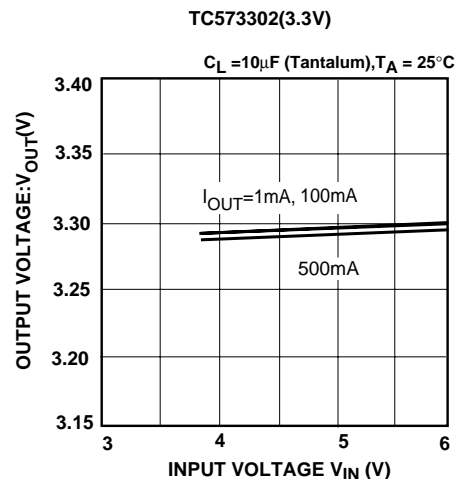
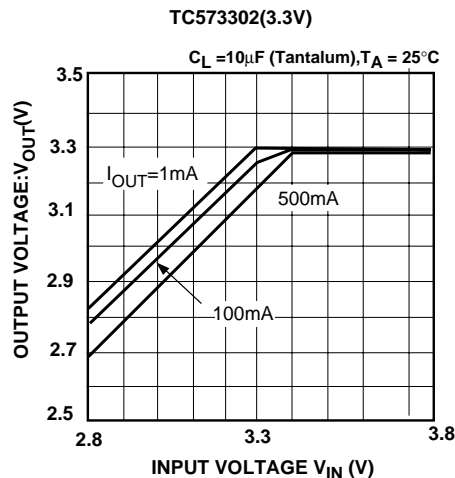
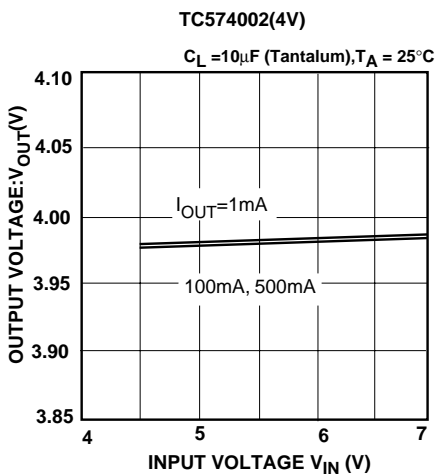
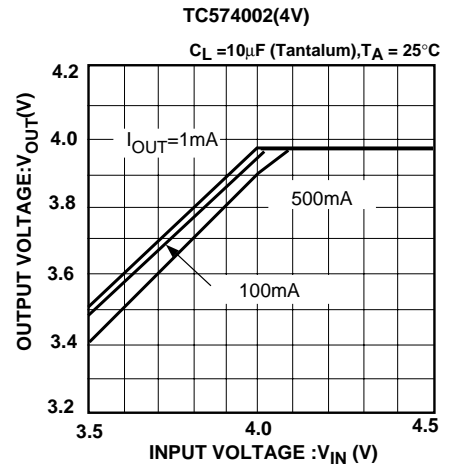
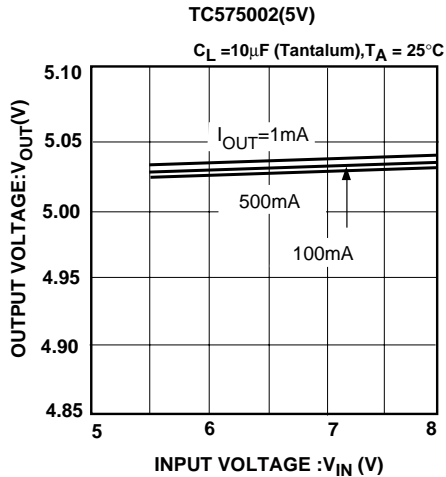
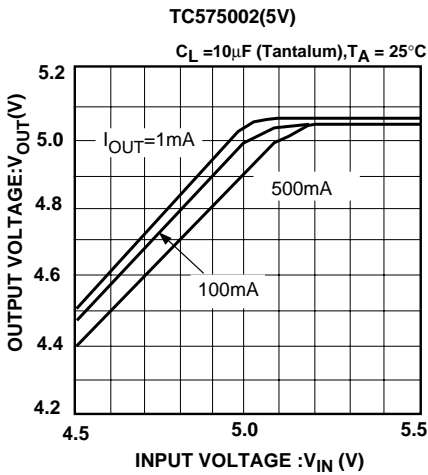

### TYPICAL CHARACTERISTICS CURVES (CONT.)

#### 3. DROPOUT VOLTAGE vs. OUTPUT CURRENT

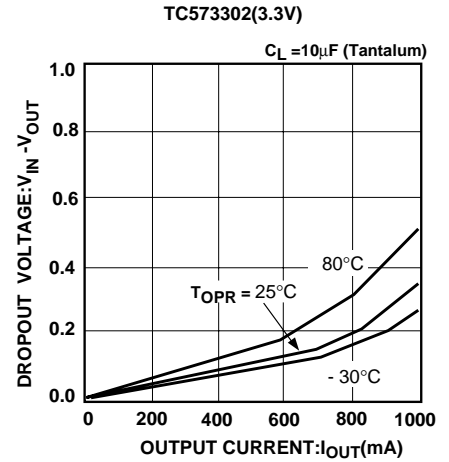
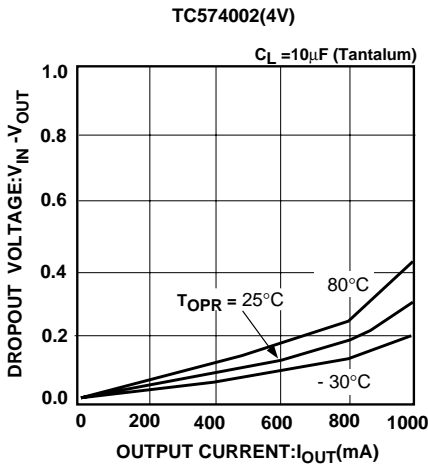
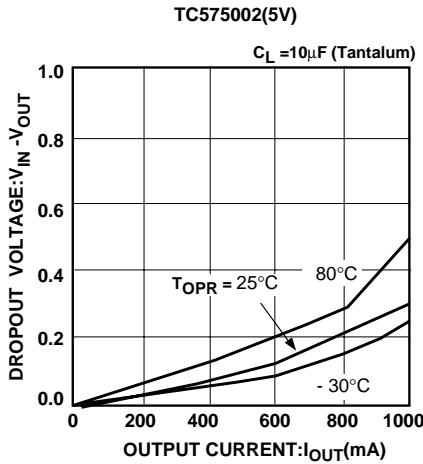

#### 4. SUPPLY CURRENT vs. INPUT VOLTAGE

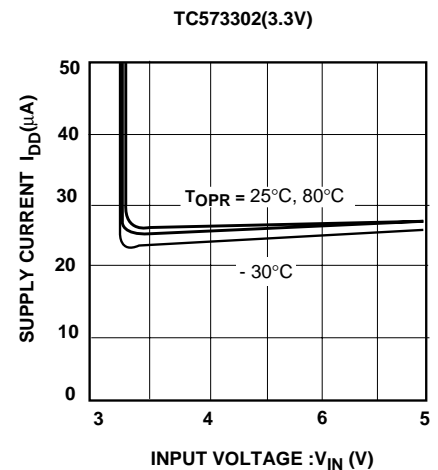
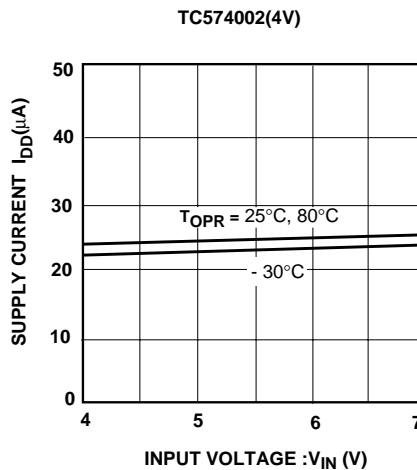
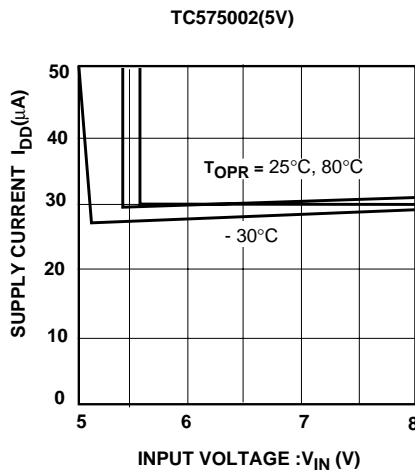

#### 5. OUTPUT VOLTAGE vs. AMBIENT TEMPERATURE

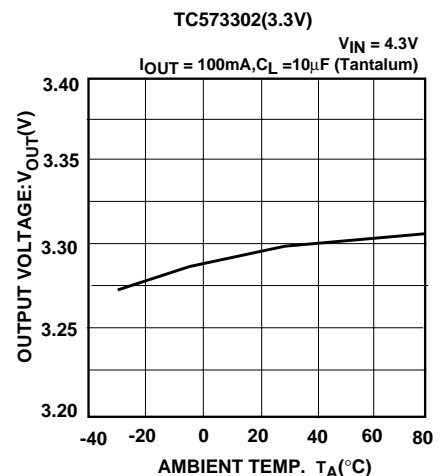
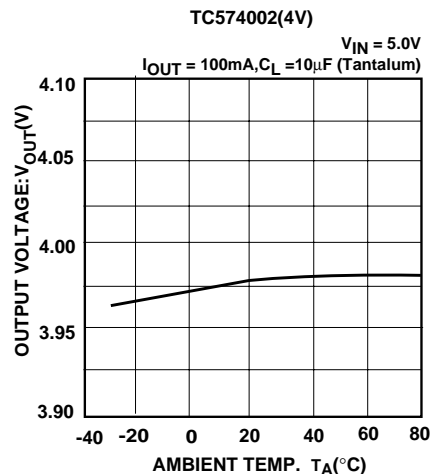
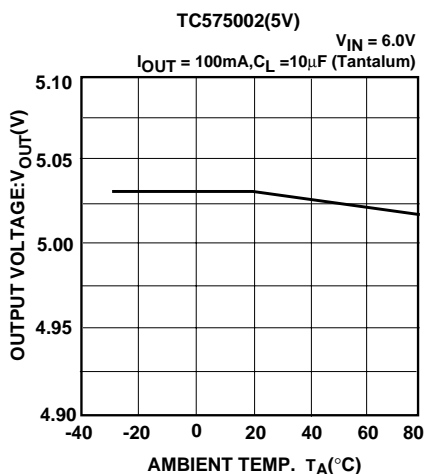

## TC57 Series

### TYPICAL CHARACTERISTICS CURVES (CONT.)

#### 6. SUPPLY CURRENT vs. AMBIENT TEMPERATURE

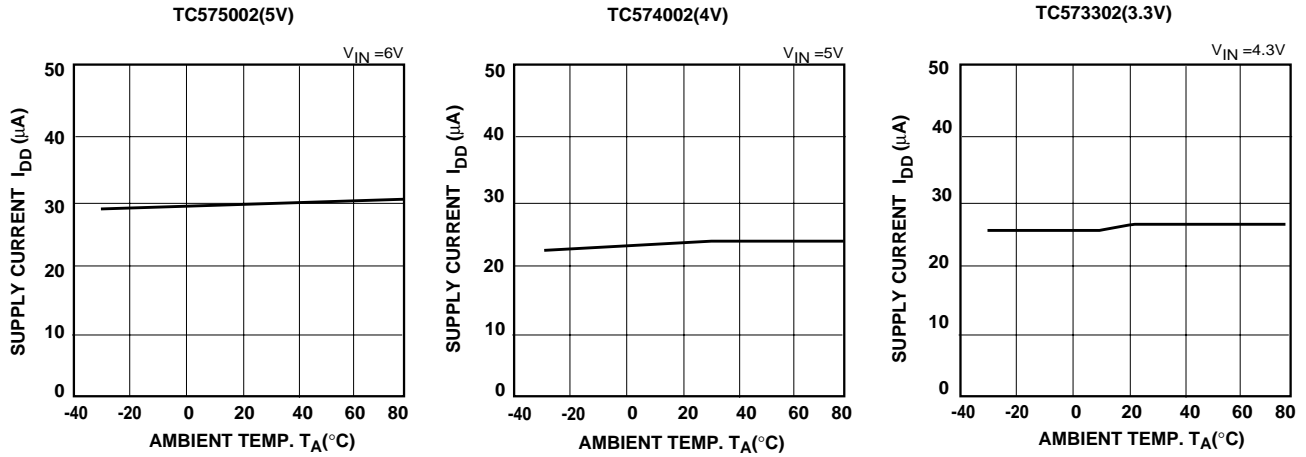

#### 7. INPUT TRANSIENT RESPONSE

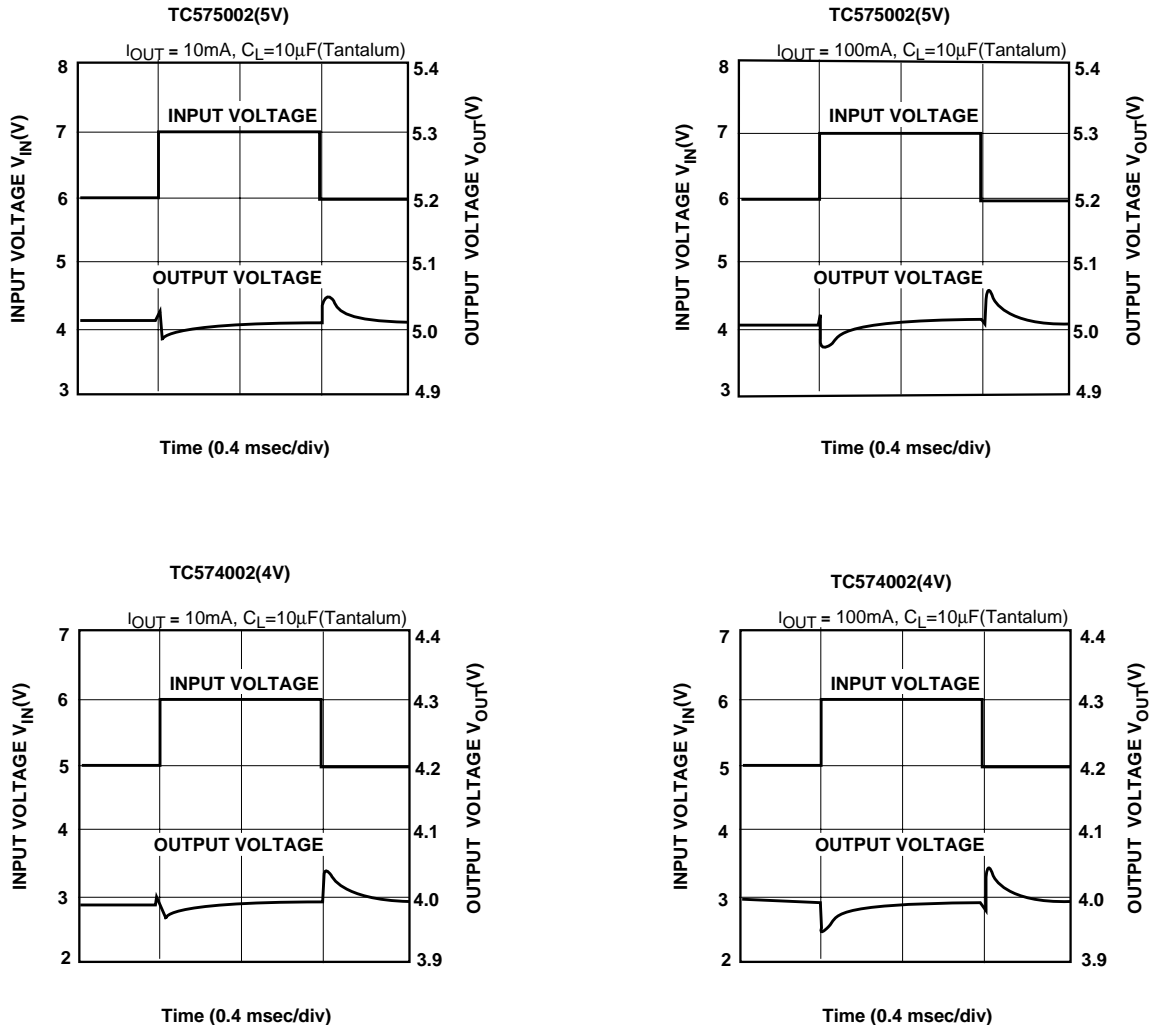



### TYPICAL CHARACTERISTICS CURVES (CONT.)

#### 7. INPUT TRANSIENT RESPONSE (CONT.)

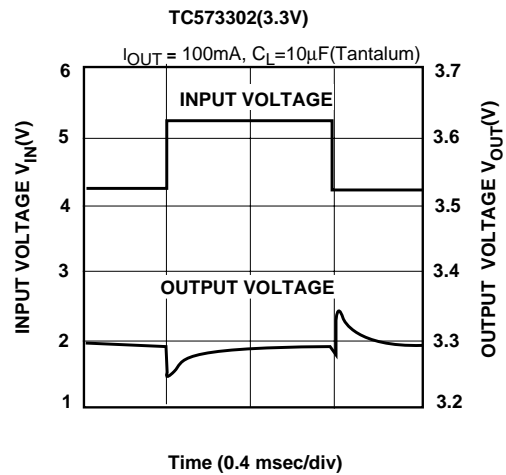
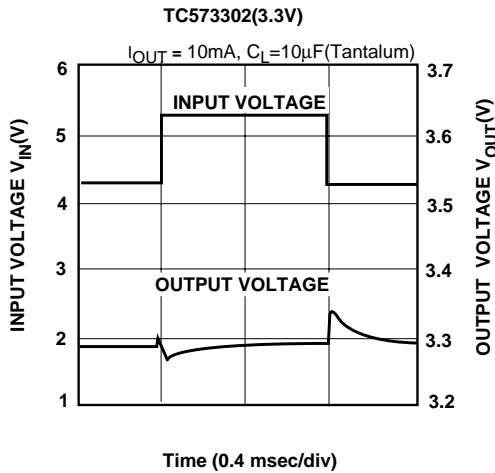

#### 8. LOAD TRANSIENT RESPONSE

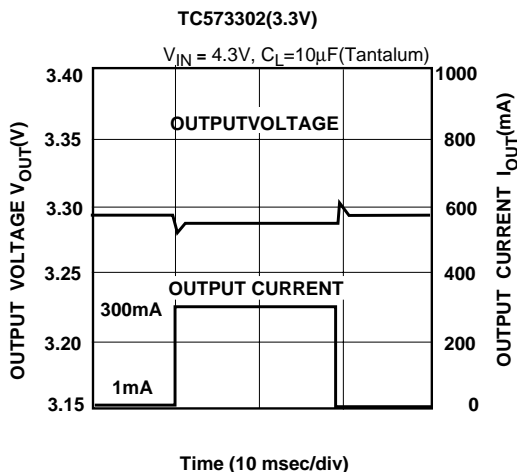
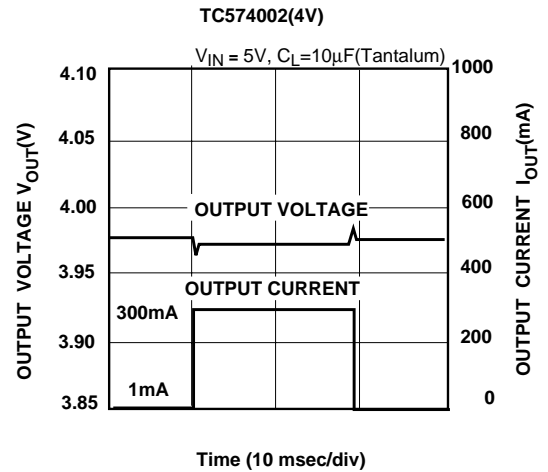
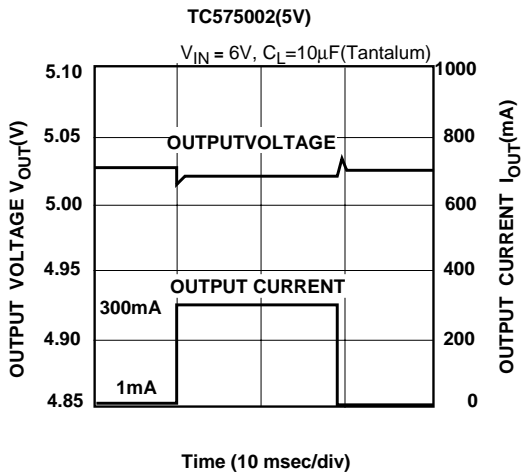

## TC57 Series

### TAPING FORM

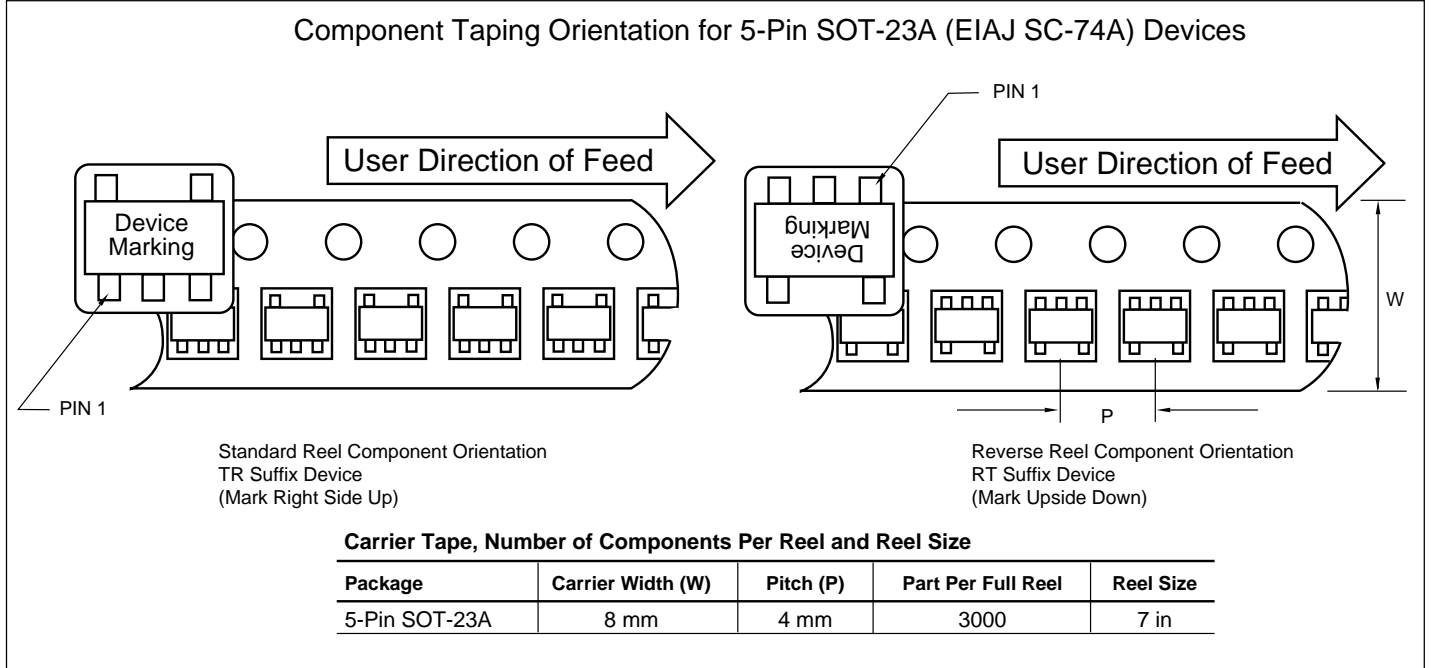

### PACKAGE DIMENSIONS

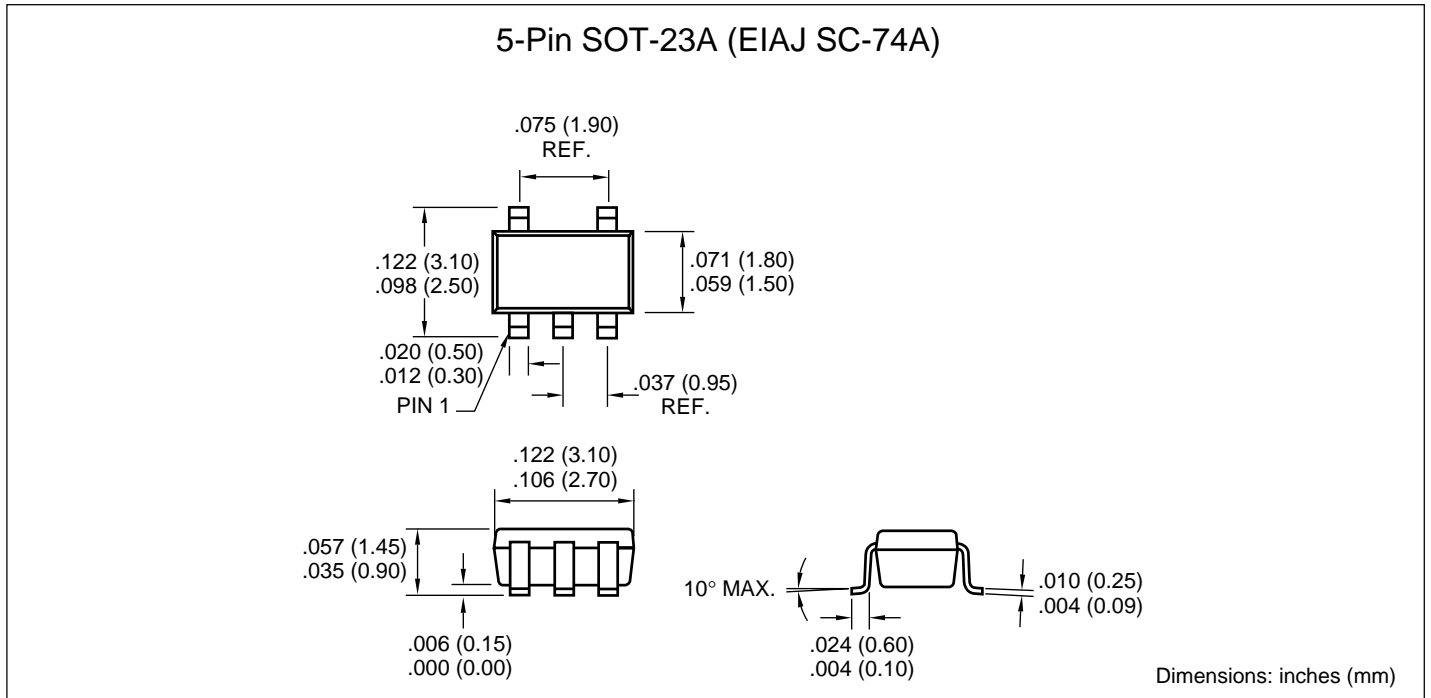



## WORLDWIDE SALES AND SERVICE

### AMERICAS

#### Corporate Office

2355 West Chandler Blvd.  
Chandler, AZ 85224-6199  
Tel: 480-792-7200 Fax: 480-792-7277  
Technical Support: 480-792-7627  
Web Address: <http://www.microchip.com>

#### Rocky Mountain

2355 West Chandler Blvd.  
Chandler, AZ 85224-6199  
Tel: 480-792-7966 Fax: 480-792-7456

#### Atlanta

500 Sugar Mill Road, Suite 200B  
Atlanta, GA 30350  
Tel: 770-640-0034 Fax: 770-640-0307

#### Austin

Analog Product Sales  
8303 MoPac Expressway North  
Suite A-201  
Austin, TX 78759  
Tel: 512-345-2030 Fax: 512-345-6085

#### Boston

2 Lan Drive, Suite 120  
Westford, MA 01886  
Tel: 978-692-3848 Fax: 978-692-3821

#### Boston

Analog Product Sales  
Unit A-8-1 Millbrook Tarry Condominium  
97 Lowell Road  
Concord, MA 01742  
Tel: 978-371-6400 Fax: 978-371-0050

#### Chicago

333 Pierce Road, Suite 180  
Itasca, IL 60143  
Tel: 630-285-0071 Fax: 630-285-0075

#### Dallas

4570 Westgrove Drive, Suite 160  
Addison, TX 75001  
Tel: 972-818-7423 Fax: 972-818-2924

#### Dayton

Two Prestige Place, Suite 130  
Miamisburg, OH 45342  
Tel: 937-291-1654 Fax: 937-291-9175

#### Detroit

Tri-Atria Office Building  
32255 Northwestern Highway, Suite 190  
Farmington Hills, MI 48334  
Tel: 248-538-2250 Fax: 248-538-2260

#### Los Angeles

18201 Von Karman, Suite 1090  
Irvine, CA 92612  
Tel: 949-263-1888 Fax: 949-263-1338

#### Mountain View

Analog Product Sales  
1300 Terra Bella Avenue  
Mountain View, CA 94043-1836  
Tel: 650-968-9241 Fax: 650-967-1590

#### New York

150 Motor Parkway, Suite 202  
Hauppauge, NY 11788  
Tel: 631-273-5305 Fax: 631-273-5335

#### San Jose

Microchip Technology Inc.  
2107 North First Street, Suite 590  
San Jose, CA 95131  
Tel: 408-436-7950 Fax: 408-436-7955

#### Toronto

6285 Northam Drive, Suite 108  
Mississauga, Ontario L4V 1X5, Canada  
Tel: 905-673-0699 Fax: 905-673-6509

### ASIA/PACIFIC

#### China - Beijing

Microchip Technology Beijing Office  
Unit 915  
New China Hong Kong Manhattan Bldg.  
No. 6 Chaoyangmen Beidajie  
Beijing, 100027, No. China  
Tel: 86-10-85282100 Fax: 86-10-85282104

#### China - Shanghai

Microchip Technology Shanghai Office  
Room 701, Bldg. B  
Far East International Plaza  
No. 317 Xian Xia Road  
Shanghai, 200051  
Tel: 86-21-6275-5700 Fax: 86-21-6275-5060

#### Hong Kong

Microchip Asia Pacific  
RM 2101, Tower 2, Metroplaza  
223 Hing Fong Road  
Kwai Fong, N.T., Hong Kong  
Tel: 852-2401-1200 Fax: 852-2401-3431

#### India

Microchip Technology Inc.  
India Liaison Office  
Divyasree Chambers  
1 Floor, Wing A (A3/A4)  
No. 11, OIShaughnessey Road  
Bangalore, 560 025, India  
Tel: 91-80-2290061 Fax: 91-80-2290062

#### Japan

Microchip Technology Intl. Inc.  
Benex S-1 6F  
3-18-20, Shinyokohama  
Kohoku-Ku, Yokohama-shi  
Kanagawa, 222-0033, Japan  
Tel: 81-45-471- 6166 Fax: 81-45-471-6122

#### Korea

Microchip Technology Korea  
168-1, Youngbo Bldg. 3 Floor  
Samsung-Dong, Kangnam-Ku  
Seoul, Korea  
Tel: 82-2-554-7200 Fax: 82-2-558-5934

### ASIA/PACIFIC (continued)

#### Singapore

Microchip Technology Singapore Pte Ltd.  
200 Middle Road  
#07-02 Prime Centre  
Singapore, 188980  
Tel: 65-334-8870 Fax: 65-334-8850

#### Taiwan

Microchip Technology Taiwan  
11F-3, No. 207  
Tung Hua North Road  
Taipei, 105, Taiwan  
Tel: 886-2-2717-7175 Fax: 886-2-2545-0139

### EUROPE

#### Australia

Microchip Technology Australia Pty Ltd  
Suite 22, 41 Rawson Street  
Epping 2121, NSW  
Australia  
Tel: 61-2-9868-6733 Fax: 61-2-9868-6755

#### Denmark

Microchip Technology Denmark ApS  
Regus Business Centre  
Lautrup høj 1-3  
Ballerup DK-2750 Denmark  
Tel: 45 4420 9895 Fax: 45 4420 9910

#### France

Arizona Microchip Technology SARL  
Parc diActivite du Moulin de Massy  
43 Rue du Saule Trapu  
Batiment A - 1er Etage  
91300 Massy, France  
Tel: 33-1-69-53-63-20 Fax: 33-1-69-30-90-79

#### Germany

Arizona Microchip Technology GmbH  
Gustav-Heinemann Ring 125  
D-81739 Munich, Germany  
Tel: 49-89-627-144 0 Fax: 49-89-627-144-44

#### Germany

Analog Product Sales  
Lochhamer Strasse 13  
D-82152 Martinsried, Germany  
Tel: 49-89-895650-0 Fax: 49-89-895650-22

#### Italy

Arizona Microchip Technology SRL  
Centro Direzionale Colleoni  
Palazzo Taurus 1 V. Le Colleoni 1  
20041 Agrate Brianza  
Milan, Italy  
Tel: 39-039-65791-1 Fax: 39-039-6899883

#### United Kingdom

Arizona Microchip Technology Ltd.  
505 Eskdale Road  
Winnersh Triangle  
Wokingham  
Berkshire, England RG41 5TU  
Tel: 44 118 921 5869 Fax: 44-118 921-5820

All rights reserved. © 2001 Microchip Technology Incorporated. Printed in the USA. 1/01  Printed on recycled paper.

01/09/01

Information contained in this publication regarding device applications and the like is intended through suggestion only and may be superseded by updates. It is your responsibility to ensure that your application meets with your specifications. No representation or warranty is given and no liability is assumed by Microchip Technology Incorporated with respect to the accuracy or use of such information, or infringement of patents or other intellectual property rights arising from such use or otherwise. Use of Microchip's products as critical components in life support systems is not authorized except with express written approval by Microchip. No licenses are conveyed, implicitly or otherwise, except as maybe explicitly expressed herein, under any intellectual property rights. The Microchip logo and name are registered trademarks of Microchip Technology Inc. in the U.S.A. and other countries. All rights reserved. All other trademarks mentioned herein are the property of their respective companies.