

EF 42

EF 42 R.F. pentode with high mutual conductance

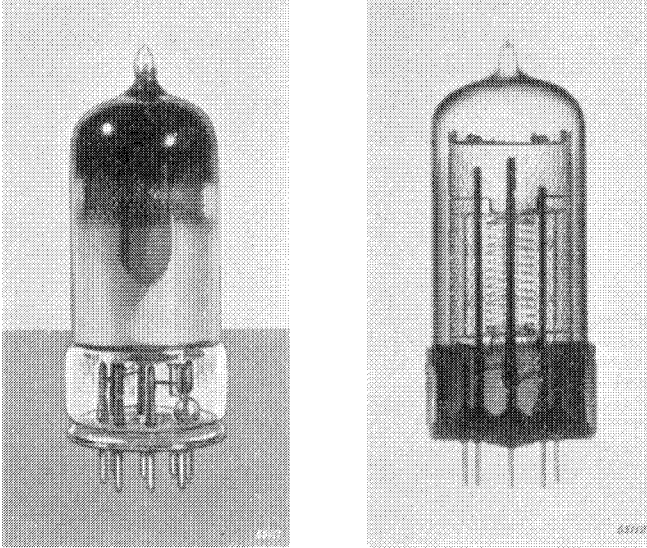

Fig. 1

Normal and X-ray photographs of the EF 42 (approximately actual size).

The EF 42 is an indirectly heated R.F. pentode with a slope of 9 mA/V at an anode current of 10 mA. Notwithstanding this high mutual conductance, the inter-electrode capacitances are small (input capacitance 9.4 pF, output capacitance 4.3 pF), for which reason the valve is an excellent wide-band amplifier for high frequencies (up to approx. 200 Mc/s). The EF 42 can also be used as a mixing valve, again at high frequencies; compared with triode-hexodes and triode-heptodes suitable for lower frequencies, this pentode has the advantages of higher conversion gain, less noise and less trouble from transit-time effects. It is even possible to use the EF 42 as a self-oscillating frequency changer, the oscillator frequency shift that accompanies any adjustment in the R.F. input circuit being reduced to negligible proportions by means of a special circuit described in a later paragraph. In the circuit in question the conversion conductance of the EF 42 is 3—4 mA/V, with an equivalent noise resistance of 3—5 k Ω .

Besides the uses already described, in view of its high mutual conductance the EF 42 is very suitable for various other purposes, such as in saw-tooth generators (as a transitron) and in cathode followers. For the latter a low output impedance is essential, and in the case of the EF 42 this is only about 100 ohms.

For use in such special circuits it is a great advantage that all the electrodes of the EF 42 are connected to separate pins.
 The entire electrode system of the valve is enclosed by an internal screen which is connected to a separate pin, thus obviating the need for external screening.

TECHNICAL DATA OF THE EF 42

Heater data

Heating: indirect, A.C. or D.C., parallel feed

Heater voltage	V_f	=	6.3 V
Heater current	I_f	=	0.33 A

Capacitances (cold valve)

Input capacitance	C_{g1}	=	9.4 pF
Output capacitance	C_a	=	4.3 pF
Between anode and control grid	C_{ag1}	<	0.006 pF
Between control grid and heater	C_{gf}	<	0.2 pF

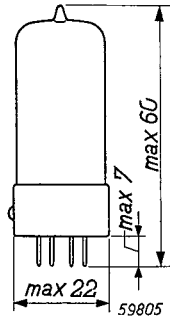
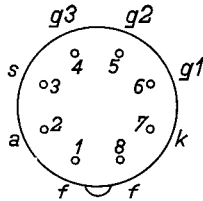
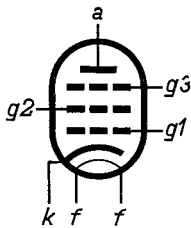

Fig. 2

Electrode arrangement, electrode connections and dimensions in mm of the EF 42.

Typical characteristics

Anode voltage	V_a	=	250 V
Voltage, grid 3	V_{g3}	=	0 V
Screen grid voltage	V_{g2}	=	250 V
Grid bias	V_{g1}	=	-2 V
Anode current	I_a	=	10 mA
Screen grid current	I_{g2}	=	2.4 mA
Mutual conductance	S	=	9 mA/V
Internal resistance	R_i	=	0.5 MΩ
Amplification factor, grid 2 with respect to grid 1	μ_{g2g1}	=	83
Equivalent noise resistance	R_{cq}	=	840 Ω

EF 42

Operating characteristics of the EF 42 used as R.F. amplifier

Anode voltage	V_a	=	250 V
Voltage, grid 3	V_{g3}	=	0 V
Screen grid voltage	V_{g2}	=	250 V
Anode current	I_a	=	10 mA
Frequency	f	=	100 Mc/s
Bandwidth	Δf	=	0.8 Mc/s
Power gain	G	=	1100

Limiting values

Anode voltage, valve biased to cut-off	V_{a_o}	= max.	550 V
Anode voltage	V_a	= max.	300 V
Anode dissipation	W_a	= max.	3.5 W
Screen grid voltage, valve biased to cut-off	V_{g2_o}	= max.	550 V
Screen grid voltage	V_{g2}	= max.	300 V
Screen grid dissipation	W_{g2}	= max.	0.7 W
Cathode current	I_k	= max.	25 mA
Grid bias	$-V_{g1}$	= max.	100 V
Grid current starting point	$V_{g1}(I_{g1} = +0.3\mu A)$	= max.	-1.3 V
External resistance between control grid and cathode	R_{g1}	= max.	1 M Ω ¹⁾
External resistance between heater and cathode	R_{fk}	= max.	20 k Ω
Voltage between heater and cathode	V_{fk}	= max.	100 V

The EF 42 used as a self-oscillating frequency changer at high frequencies

Fig. 3 shows the cathode and the first and second grids of the EF 42 connected as a Colpitts oscillator. The tuned circuit is formed by the coil L_1

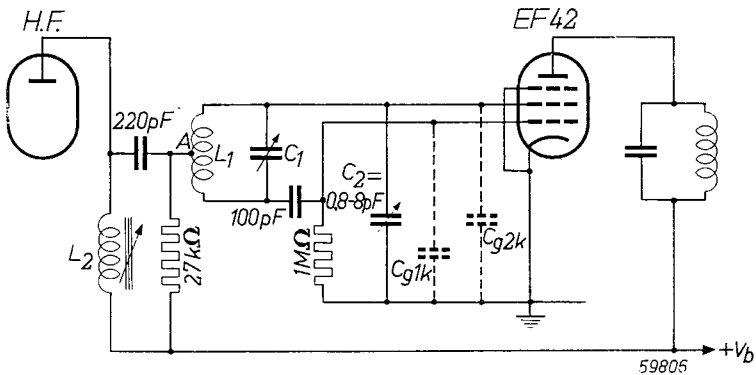

Fig. 3

¹⁾ With automatic grid bias.

and capacitor C_1 , in conjunction with the inter-electrode capacitances C_{g1k} and C_{g2k} . The two last-named capacitances virtually constitute a capacitive voltage divider, so that the cathode is connected to a tapping in the tuned circuit. At a point A on coil L_1 , the oscillator voltage with respect to the cathode is practically zero, the actual location of this point being dependent on the magnitude of C_{g1k} and C_{g2k} . With the aid of the trimmer C_2 in parallel with C_{g2k} , the point A can be made to coincide with a tapping taken from the same coil. Now, since there is practically no oscillator voltage between this tapping and the cathode, the output of an R.F. amplifier can be connected across these points without noticeably affecting the oscillator. Furthermore, the oscillator frequency will then undergo only the slightest displacement when the R.F. amplifier is tuned.

If the oscillator frequency exceeds the frequency of the R.F. signals, capacitive impedance to this R.F. signal occurs between point A and the cathode. By means of the adjustable coil L_2 in the anode circuit of the R.F. amplifier, this capacitance can be brought into series resonance with the self-inductance of L_2 . For an R.F. signal of 60 Mc/s, with an intermediate frequency of 26 Mc/s, it is thus possible to obtain an amplification of from 75 to 90 between the control grid of the R.F. amplifying valve and that of the first I.F. valve, with a bandwidth of 3.5 Mc/s.

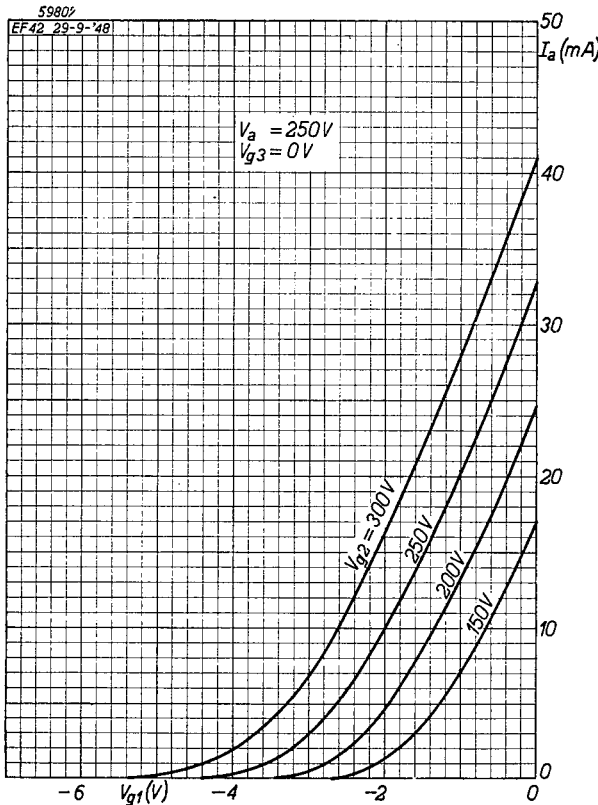

Fig. 4
 I_a/V_{g1} characteristics of
the EF 42.

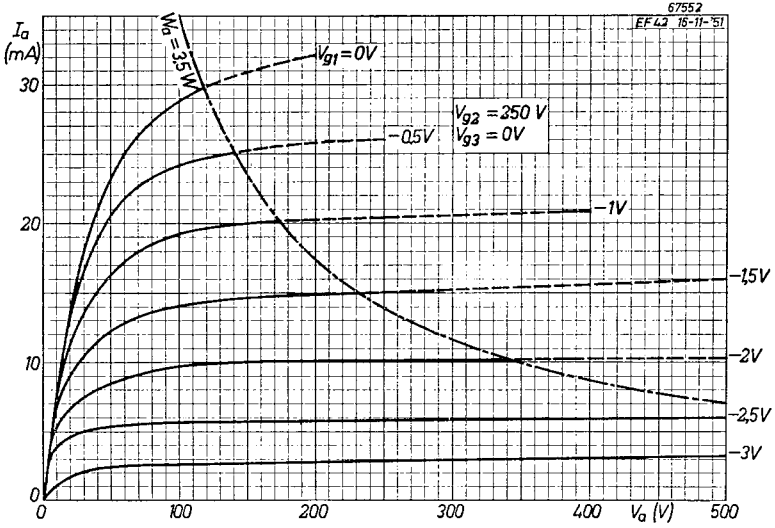

Fig. 5
 I_a/V_a characteristics of the EF 42. The broken line indicates the maximum permissible anode dissipation ($W_a = 3.5 W$).

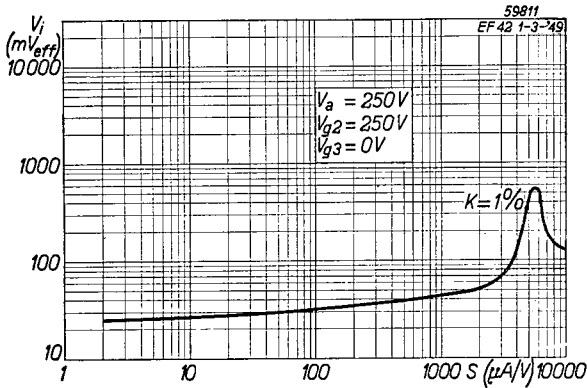

Fig. 6
The effective voltage (V_i) of an interfering signal at the control grid, producing 1% cross-modulation, as a function of the mutual conductance.