

# INDICATOR TUBE

Cold cathode ten digit numeral indicator tube for side viewing.

QUICK REFERENCE DATA			
Numeral height		30	mm
Numerals	1 2 3 4 5 6 7 8 9 0		
Supply voltage	$V_{ba}$	min. 170	V
Cathode current	$I_k$	4.5	mA

## GENERAL

The numerals are 30 mm high and appear on the same base line allowing in-line read out. The ZM1040 is provided with a red contrast filter.

## PRINCIPLE OF OPERATION

The tube contains ten cathodes in the form of ten figures and one common anode. By applying a suitable voltage between the anode and one of the ten cathodes the corresponding numeral will be covered by a red neon glow.

## DIMENSIONS AND CONNECTIONS

Dimensions in mm

Base: B13B

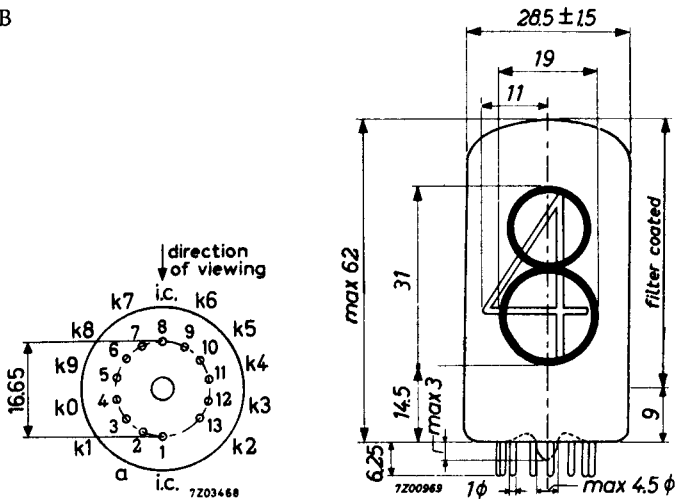

7Z2 5256

Mounting position: any

The numerals are viewed through the side of the envelope. The numerals will appear upright (within  $1.5^\circ$ ) when the tube is mounted vertically.

## Accessories

Socket type B870228 (B870067 or B870069)

## CHARACTERISTICS AND OPERATING CONDITIONS

Ignition voltage	$V_{ign}$	max.	160	V
Maintaining voltage	$V_m$	see sheets A and B		
Cathode current for coverage, average, during any conduction period	$I_k$	min.	3	mA
Cathode current, average ( $T_{av} = 20$ ms)	$I_k$	max.	6	mA
peak	$I_{kp}$	max.	20	mA
Cathode selecting voltage	$V_{kk}$	see sheets C and D		
Extinguishing voltage	$V_{ext}$	min.	120	V

Typical operation at temperatures  $t_{amb} = 10$  to  $50^\circ\text{C}$

### D.C. operation with or without $V_{kk}$

(See fig. 1 and 3 and sheets A, C and D)

Anode supply voltage	$V_{ba}$	200	250	300	350	V
Maintaining voltage	$V_m$	$140 \pm 10$	$140 \pm 10$	$140 \pm 10$	$140 \pm 10$	V
Anode series resistor	$R_a$	15	27	39	47	$k\Omega$
Cathode selecting voltage	$V_{kk}$			min.	60	V <sup>1)</sup>

### A.C. half-wave rectified operation with or without $V_{kk}$

(See fig. 2 and 4 and sheet B)

Secondary transformer voltage	$V_{tr}$	170	220	250	300	V
Anode series resistor	$R_a$	5.6	12	18	27	$k\Omega$
Cathode selecting voltage	$V_{kk}$			min.	60	V <sup>1)</sup>

<sup>1)</sup> With low cathode selecting voltages the current  $I_{kk}$  to the "off" cathodes will increase and the readability of the "on" cathode will be affected. It is therefore recommended to use a voltage  $V_{kk}$  in excess of the stated minimum value.

7Z2 5257

**LIFE EXPECTANCY** under recommended operating conditions

Continuous display of one digit	3000 h
Sequentially changing the display from one digit to the others every 100 hours or less	20 000 h

**LIMITING VALUES** (Absolute max. rating system)

Anode voltage necessary for ignition	$V_a$	min.	170 V
Cathode current,			
average during any conduction period	$I_k$	min.	3 mA
average ( $T_{av} = 20$ ms)	$I_k$	max.	6 mA
peak	$I_{kp}$	max.	20 mA
Cathode selection voltage	$V_{kk}$	min.	60 V
Bias voltage between anode and "off" cathodes	$V_{bias}$	max.	120 V
Bulb temperature	$t_{bulb}$	min.	0 °C
		max.	+70 °C <sup>1)</sup>

<sup>1)</sup> Bulb temperatures below 0 °C result in a reduced life expectancy and changes in characteristics (see sheet E)

In designing equipment to be used over a wide temperature range the use of "constant current operation" (high supply voltage with a high anode series resistor) is recommended.

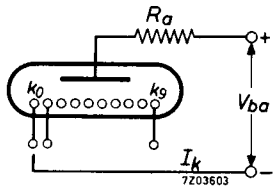

Fig.1

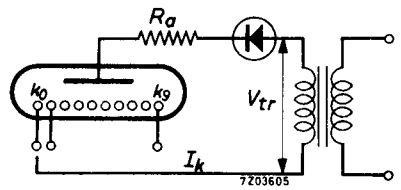

Fig.2

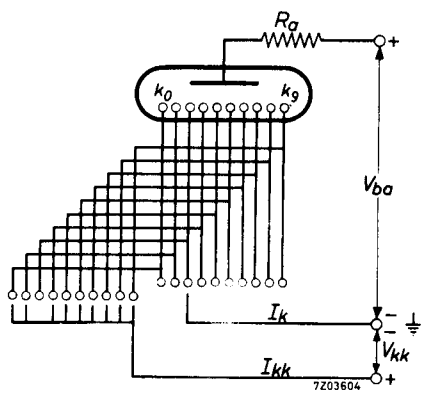

Fig.3

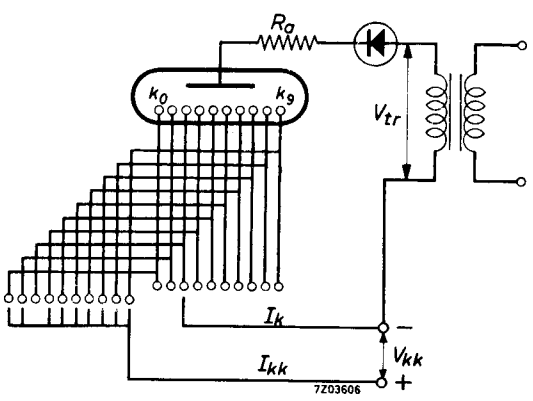
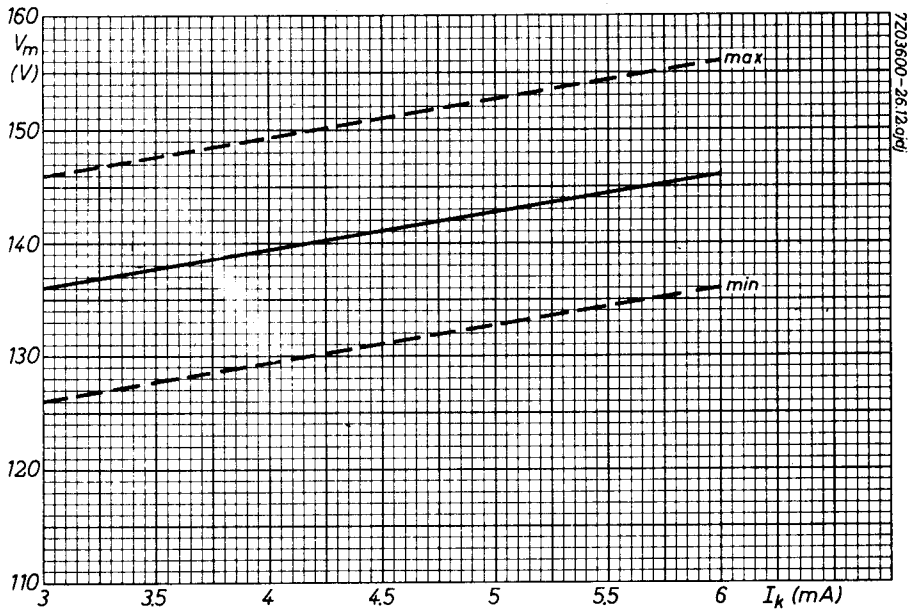
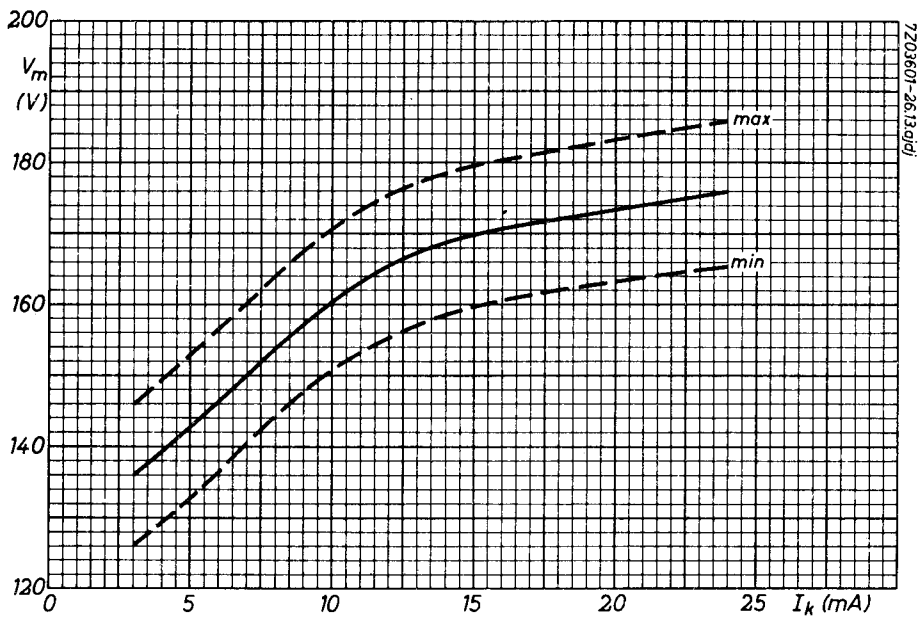

Fig.4





7203601-26139/d1

