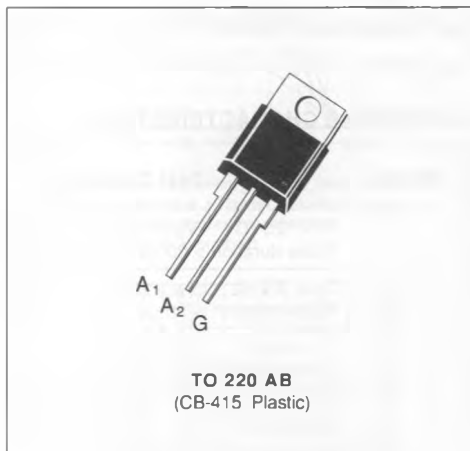

SNUBBERLESS TRIACS

- $I_{TRMS} = 16\text{ A}$ at $T_c = 80\text{ }^\circ\text{C}$.
- $V_{DRM} : 200\text{ V}$ to 800 V .
- $I_{GT} = 35\text{ mA}$ (QI-II-III).
- GLASS PASSIVATED CHIP.
- HIGH SURGE CURRENT : $I_{TSM} = 150\text{ A}$.
- HIGH COMMUTATION CAPABILITY :
(di/dt)_c > 8.5 A/ms without snubber.
- INSULATING VOLTAGE : 2500 V_{RMS} .
- UL RECOGNIZED (E81734).

DESCRIPTION

New range suited for applications such as phase control and static switching on inductive or resistive load.

ABSOLUTE RATINGS (limiting values)

Symbol	Parameter		Value	Unit
I_{TRMS}	RMS on-state current (360 ° conduction angle)	$T_c = 80\text{ }^\circ\text{C}$	16	A
I_{TSM}	Non repetitive surge peak on-state current (T_j initial = $25\text{ }^\circ\text{C}$)	$t = 8.3\text{ ms}$	157	A
		$t = 10\text{ ms}$	150	
i^2t	i^2t value	$t = 10\text{ ms}$	112	A^2s
di/dt	Critical rate of rise of on-state current (1)	Repetitive $F = 50\text{ Hz}$	20	$\text{A}/\mu\text{s}$
		Non Repetitive	100	
T_{stg} T_j	Storage and operating junction temperature range		- 40, + 150 - 40, + 125	$^\circ\text{C}$ $^\circ\text{C}$

Symbol	Parameter	BTA 16-					Unit
		200 CW	400 CW	600 CW	700 CW	800 CW	
V_{DRM}	Repetitive peak off-state voltage (2)	± 200	± 400	± 600	± 700	± 800	V

(1) Gate supply : $I_G = 350\text{ mA}$ - $di_G/dt = 1\text{ A}/\mu\text{s}$

(2) $T_j = 125\text{ }^\circ\text{C}$.

THERMAL RESISTANCES

Symbol	Parameter	Value	Unit
$R_{th(j-a)}$	Junction to ambient	60	°C/W
$R_{th(j-c)}$ DC	Junction to case for DC	3.1	°C/W
$R_{th(j-c)}$ AC	Junction to case for 360 ° conduction angle (F = 50 Hz)	2.3	°C/W

GATE CHARACTERISTICS (maximum values)

$P_{GM} = 40\text{ W}$ ($t = 10\ \mu\text{s}$) $P_{G(AV)} = 1\text{ W}$ $I_{GM} = 4\text{ A}$ ($t = 10\ \mu\text{s}$) $V_{GM} = 16\text{ V}$ ($t = 10\ \mu\text{s}$).

ELECTRICAL CHARACTERISTICS

Symbol	Test Conditions	Quadrants	Min.	Typ.	Max.	Unit
I_{GT}	$T_j = 25\text{ °C}$ $V_D = 12\text{ V}$ $R_L = 33\ \Omega$ Pulse duration > 20 μs	I-II-III	1		35	mA
V_{GT}	$T_j = 25\text{ °C}$ $V_D = 12\text{ V}$ $R_L = 33\ \Omega$ Pulse duration > 20 μs	I-II-III			1.5	V
V_{GD}	$T_j = 125\text{ °C}$ $V_D = V_{DRM}$ $R_L = 3.3\text{ k}\Omega$ Pulse duration > 20 μs	I-II-III	0.2			V
I_H^*	$T_j = 25\text{ °C}$ $I_T = 100\text{ mA}$ Gate open $R_L = 140\ \Omega$				35	mA
I_{LL}	$T_j = 25\text{ °C}$ $V_D = 12\text{ V}$ $I_G = 350\text{ mA}$ Pulse duration > 20 μs	I-III			50	mA
		II			80	
V_{TM}^*	$T_j = 25\text{ °C}$ $I_{TM} = 22.5\text{ A}$ $t_p = 10\text{ ms}$				1.5	V
I_{DRM}^*	$T_j = 25\text{ °C}$ $T_j = 125\text{ °C}$ V_{DRM} rated Gate open				0.01	mA
					2	
dv/dt^*	$T_j = 125\text{ °C}$ Gate open Linear slope up to 0.67 V_{DRM}		250	500		V/ μs
$(di/dt)_c^*$	$T_j = 125\text{ °C}$ V_{DRM} rated Without snubber		8.5	17		A/ms
t_{GI}	$T_j = 25\text{ °C}$ $di_G/dt = 1\text{ A}/\mu\text{s}$ $I_G = 350\text{ mA}$ $I_T = 22.5\text{ A}$ $V_D = V_{DRM}$	I-II-III		2		μs

* For either polarity of electrode A₂ voltage with reference to electrode A₁.

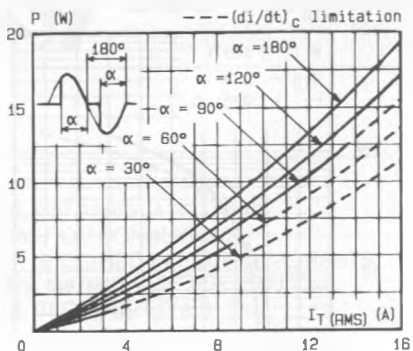

Fig.1 - Maximum mean power dissipation versus RMS on-state current ($F = 60 \text{ Hz}$).

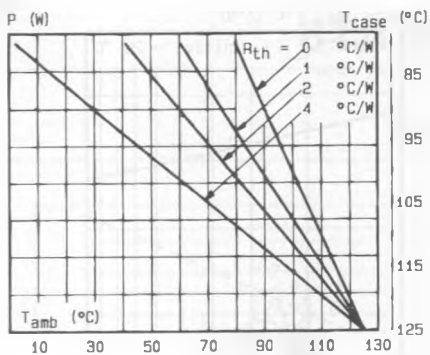

Fig.2 - Correlation between maximum mean power dissipation and maximum allowable temperatures (T_{amb} and T_{case}) for different thermal resistances heatsink + contact.

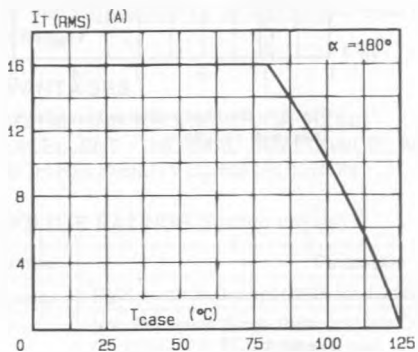

Fig.3 - RMS on-state current versus case temperature.

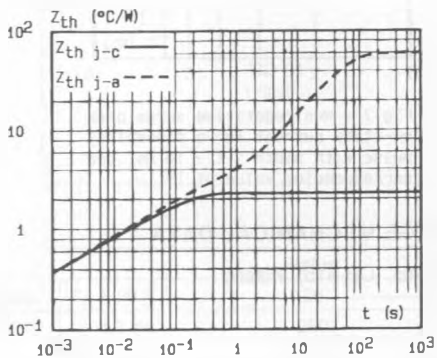

Fig.4 - Thermal transient impedance junction to case and junction to ambient versus pulse duration.

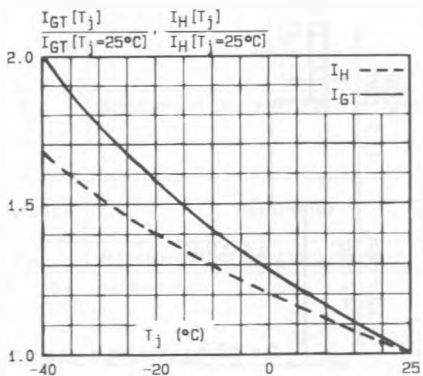

Fig.5 - Relative variation of gate trigger current and holding current versus junction temperature.

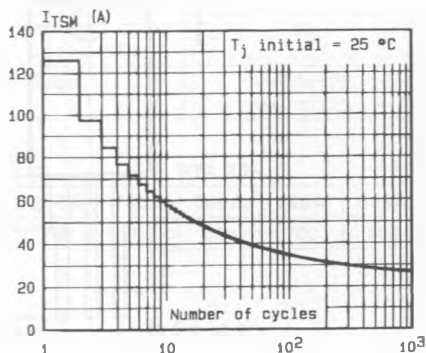

Fig.6 - Non repetitive surge peak on-state current versus number of cycles.

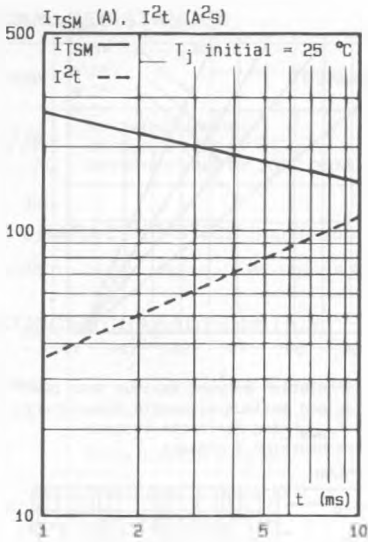

Fig.7 - Non repetitive surge peak on-state current for a sinusoidal pulse with width : $t \leq 10$ ms, and corresponding value of I^2t .

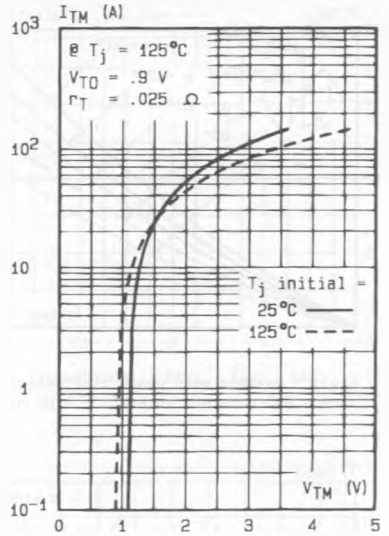
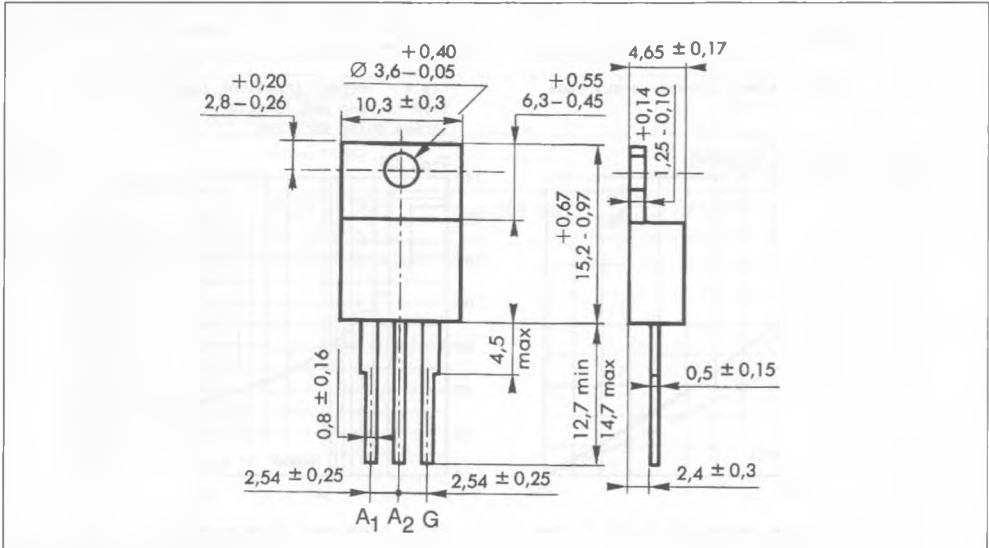

Fig.8 - On-state characteristics (maximum values).

PACKAGE MECHANICAL DATA

TO 220 AB (CB-415) Plastic



Cooling method : by conduction (method C)
 Marking : type number
 Weight : 2 g