

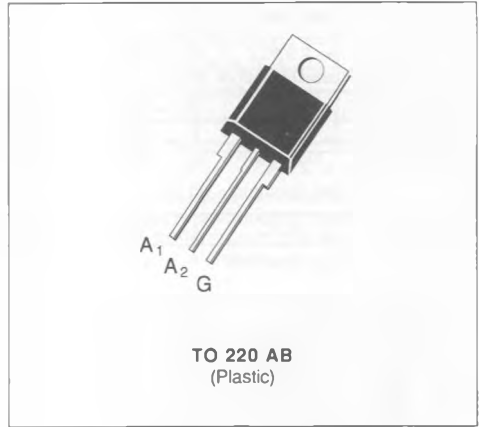

**TRIACS**

- GLASS PASSIVATED CHIP
- EXCELLENT  $(dv/dt)_c > 5 V/\mu s$
- $I_{GT}$  SPECIFIED IN FOUR QUADRANTS
- AVAILABLE IN INSULATED VERSION → BTA SERIES (INSULATING VOLTAGE 2500  $V_{RMS}$ ) OR IN UNINSULATED VERSION → BTB SERIES
- UL RECOGNIZED FOR BTA SERIES (E81734)



**DESCRIPTION**

New range suited for applications such as phase control and static switching.

**ABSOLUTE RATINGS** (limiting values)

Symbol	Parameter	Value	Unit
$I_{T(RMS)}$	RMS on-state Current (360° conduction angle)	$T_C = 75\text{ }^\circ\text{C}$ 10	A
$I_{TSM}$	Non Repetitive Surge Peak on-state Current ( $T_j$ initial = 25 °C - Half sine wave)	$t = 8.3\text{ ms}$	105
		$t = 10\text{ ms}$	100
$I^2t$	$I^2t$ Value for Fusing	$t = 10\text{ ms}$ 50	A <sup>2</sup> s
$di/dt$	Critical Rate of Rise of on-state Current (1)	Repetitive F = 50 Hz	10
		Non Repetitive	50
$T_{stg}$ $T_j$	Storage and Operating Junction Temperature Range	- 40 to 150	°C
		- 40 to 110	°C

Symbol	Parameter	BTA/BTB 10-					Unit
		200C	400C	600C	700C	800C	
$V_{DRM}$	Repetitive Peak off-state Voltage (2)	200	400	600	700	800	V

(1)  $I_G = 500\text{ mA}$   $di_c/dt = 1\text{ A}/\mu s$

(2)  $T_j = 110\text{ }^\circ\text{C}$ .

**THERMAL RESISTANCES**

Symbol	Parameter	Value	Unit
$R_{th(j-a)}$	Junction to Ambient	60	°C/W
$R_{th(j-c)}\text{ DC}$	Junction to Case for DC	3.9	°C/W
$R_{th(j-c)}\text{ AC}$	Junction to Case for 360° Conduction Angle (F = 50 Hz)	2.9	°C/W

**GATE CHARACTERISTICS** (maximum values)

$P_{GM} = 40 \text{ W}$  ( $t_p = 10 \mu\text{s}$ )       $I_{GM} = 4 \text{ A}$  ( $t_p = 10 \mu\text{s}$ )  
 $P_{G(AV)} = 1 \text{ W}$        $V_{GM} = 16 \text{ V}$  ( $t_p = 10 \mu\text{s}$ )

**ELECTRICAL CHARACTERISTICS**

Symbol	Test Conditions	Quadrants	Min.	Typ.	Max.	Unit
$I_{GT}$	$T_j = 25 \text{ }^\circ\text{C}$ $V_D = 12 \text{ V}$ $R_L = 33 \text{ } \Omega$ Pulse Duration > 20 $\mu\text{s}$	I-II-III			25	mA
		IV			50	
$V_{GT}$	$T_j = 25 \text{ }^\circ\text{C}$ $V_D = 12 \text{ V}$ $R_L = 33 \text{ } \Omega$ Pulse Duration > 20 $\mu\text{s}$	I-II-III-IV			1.5	V
$V_{GD}$	$T_j = 110 \text{ }^\circ\text{C}$ $V_D = V_{DRM}$ $R_L = 3.3 \text{ k}\Omega$	I-II-III-IV	0.2			V
$I_H^*$	$T_j = 25 \text{ }^\circ\text{C}$ $I_T = 100 \text{ mA}$ Gate Open				25	mA
$I_L$	$T_j = 25 \text{ }^\circ\text{C}$ $V_D = 12 \text{ V}$ $I_G = 100 \text{ mA}$ Pulse Duration > 20 $\mu\text{s}$	I-III-IV		50		mA
		II		100		
$V_{TM}^*$	$T_j = 25 \text{ }^\circ\text{C}$ $I_{TM} = 14 \text{ A}$ $t_p = 10 \text{ ms}$				1.5	V
$I_{DRM}^*$	$V_{DRM}$ Specified				0.01	mA
					$T_j = 25 \text{ }^\circ\text{C}$	
	$T_j = 110 \text{ }^\circ\text{C}$ Gate Open Linear Slope up to $V_D = 67\% V_{DRM}$		100	200		V/ $\mu\text{s}$
$(dv/dt)_c^*$	$T_C = 75 \text{ }^\circ\text{C}$ $V_D = V_{DRM}$ $I_T = 14 \text{ A}$ $(di/dt)_c = 4.4 \text{ A/ms}$		5			V/ $\mu\text{s}$
$t_{gt}$	$T_j = 25 \text{ }^\circ\text{C}$ $V_D = V_{DRM}$ $I_T = 14 \text{ A}$ $I_G = 80 \text{ mA}$ $di_G/dt = 1 \text{ A}/\mu\text{s}$	I-II-III-IV		2		$\mu\text{s}$

\* For either polarity of electrode A<sub>2</sub> voltage with reference to electrode A<sub>1</sub>.

**PACKAGE MECHANICAL DATA**

TO 220 AB Plastic

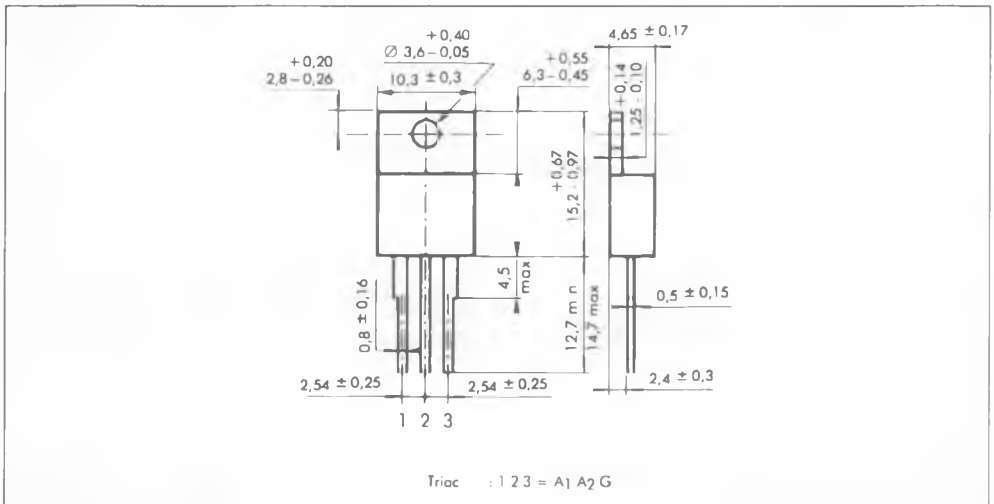

Cooling method : by conduction (method C)  
 Marking : type number  
 Weight : 2 g.

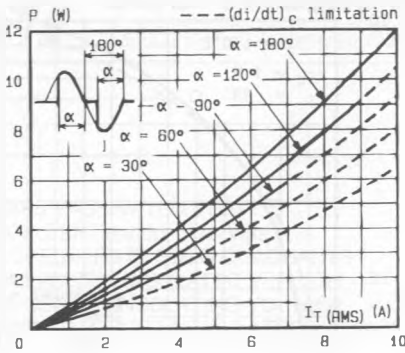

Fig. 1 - Maximum mean power dissipation versus RMS on-state current ( $F = 60 \text{ Hz}$ ).

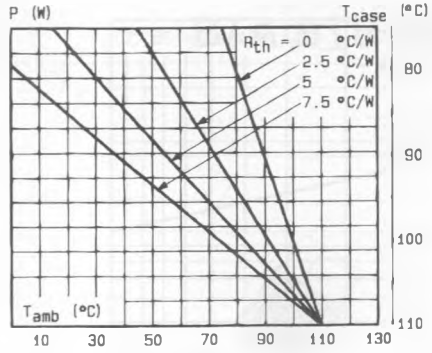

Fig. 2 - Correlation between maximum mean power dissipation and maximum allowable temperatures ( $T_{amb}$  and  $T_{case}$ ) for different thermal resistances heatsink + contact.

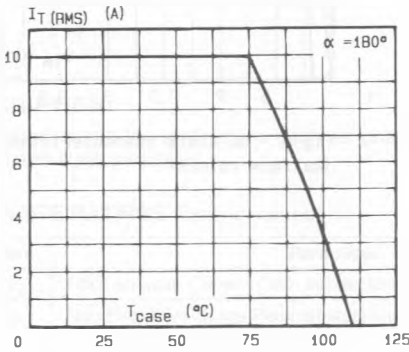

Fig. 3 - RMS on-state current versus case temperature.

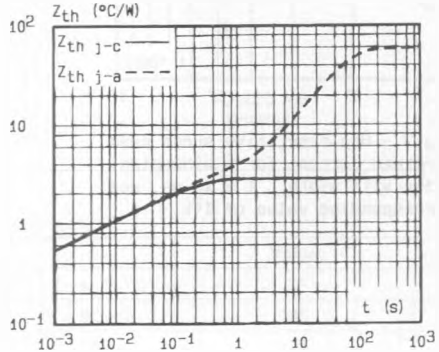

Fig. 4 - Thermal transient impedance junction to case and junction to ambient versus pulse duration.

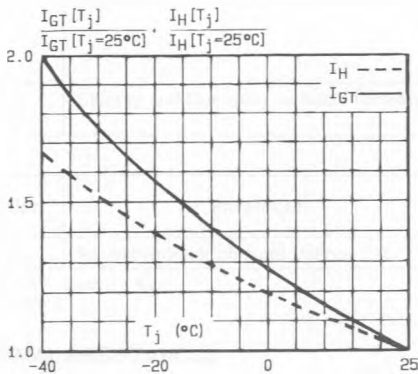

Fig. 5 - Relative variation of gate trigger current and holding current versus junction temperature.

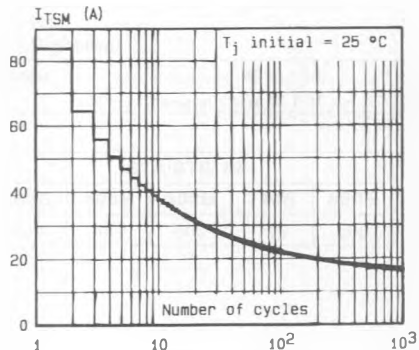

Fig. 6 - Non repetitive surge peak on-state current versus number of cycles.

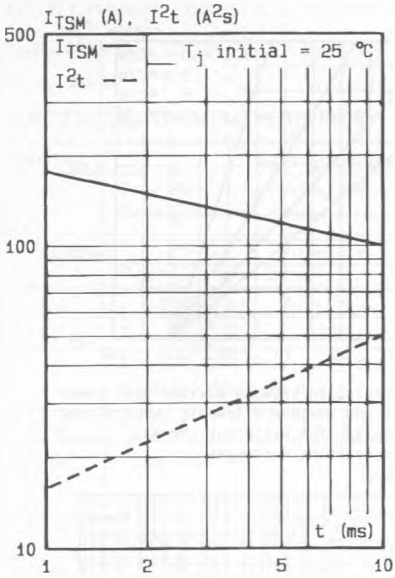

Fig.7 - Non repetitive surge peak on-state current for a sinusoidal pulse with width :  $t \leq 10$  ms, and corresponding value of  $I^2t$ .

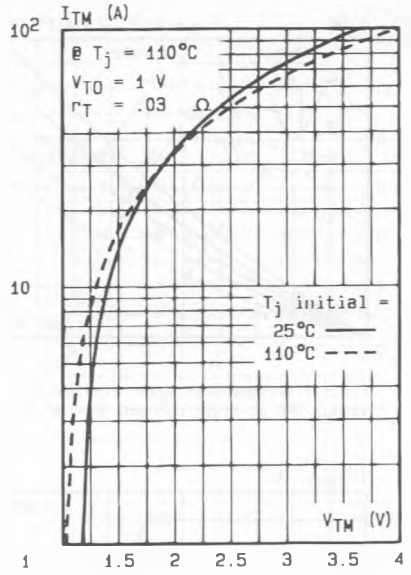

Fig.8 - On-state characteristics (maximum values).