



SENSITIVE GATE TRIACS

- GLASS PASSIVATED CHIP
- HIGH SURGE CURRENT

DESCRIPTION

Low power triacs suited for 50 and 60 Hz up to 380 V_{RMS}.

APPLICATIONS

- CONTROL SPEED FOR LITTLE MOTORS ; ELECTRIC PUMP OR VENTILATOR, SEWING MACHINE
- RELAY, DETECTOR, ALARM SYSTEM
- ELECTRONIC STARTER FOR LAMP
- HIGH POWER TRIAC DRIVER

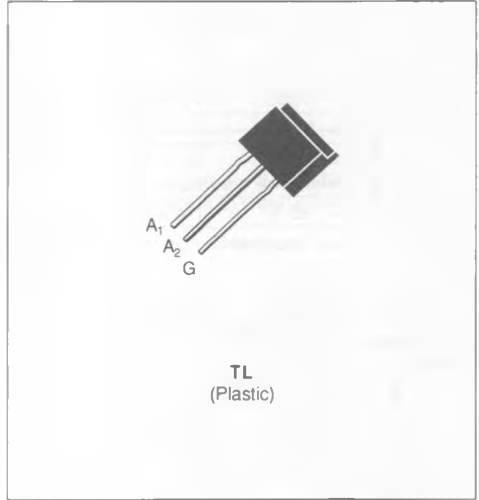

ABSOLUTE RATINGS (limiting values)

Symbol	Parameter		Value	Unit
$I_{T(RMS)}$	RMS on-state Current (360° conduction angle)	$T_J = 40\text{ °C}$	1	A
$I_{T(RMS)}$	RMS on-state Current on Printed Circuit (360° conduction angle)	$T_a = 25\text{ °C}$	0.77	A
I_{TSM}	Non Repetitive Surge Peak on-state Current (T_J initial = 25 °C - Half sine wave)	$t = 8.3\text{ ms}$	16	A
		$t = 10\text{ ms}$	15	
I^2t	I^2t Value for Fusing	$t = 10\text{ ms}$	1.125	A ² s
di/dt	Critical Rate of Rise of on-state Current (1)	Repetitive	10	A/μs
T_{stg} T_J	Storage and Operating Junction Temperature Range		- 40 to 150	°C
			- 40 to 110	°C

Symbol	Parameter	TLC111T	TLC221T	TLC331T	TLC381T	Unit
V_{DRM}	Repetitive Peak off-state Voltage (2)	200	400	600	700	V

(1) $I_G = 50\text{ mA}$ $di_G/dt = 1\text{ A/μs}$

(2) $T_J = 110\text{ °C}$.

THERMAL RESISTANCES

Symbol	Parameter	Value	Unit
$R_{th(j-a)}$	Junction to Ambient on Printed Circuit	75	°C/W
$R_{th(j-l)}$	Junction-leads for 360° Conduction Angle ($F = 50\text{ Hz}$)	45	°C/W

GATE CHARACTERISTICS (maximum values)

$P_{GM} = 2 \text{ W}$ ($t_p = 10 \mu\text{s}$) $I_{GM} = 1 \text{ A}$ ($t_p = 10 \mu\text{s}$)
 $P_{G(AV)} = 0.1 \text{ W}$ $V_{GM} = 16 \text{ V}$ ($t_p = 10 \mu\text{s}$)

ELECTRICAL CHARACTERISTICS

Symbol	Test Conditions			Quadrants	Min.	Typ.	Max.	Unit
I_{GT}	$T_j = 25 \text{ }^\circ\text{C}$ Pulse Duration > 20 μs	$V_D = 12 \text{ V}$	$R_L = 33 \text{ } \Omega$	I-II-III-IV			5	mA
V_{GT}	$T_j = 25 \text{ }^\circ\text{C}$ Pulse Duration > 20 μs	$V_D = 12 \text{ V}$	$R_L = 33 \text{ } \Omega$	I-II-III-IV			1.5	V
V_{GD}	$T_j = 110 \text{ }^\circ\text{C}$	$V_D = V_{DRM}$	$R_L = 3.3 \text{ k}\Omega$	I-II-III-IV	0.2			V
I_H^*	$T_j = 25 \text{ }^\circ\text{C}$	$I_T = 100 \text{ mA}$	Gate Open				15	mA
I_L	$T_j = 25 \text{ }^\circ\text{C}$ Pulse Duration > 20 μs	$V_D = 12 \text{ V}$	$I_G = 10 \text{ mA}$	I-II-III-IV			15	mA
V_{TM}^*	$T_j = 25 \text{ }^\circ\text{C}$	$I_{TM} = 1.4 \text{ A}$	$t_p = 10 \text{ ms}$				1.8	V
I_{DRM}^*	V_{DRM} Specified	$T_j = 25 \text{ }^\circ\text{C}$					0.01	mA
		$T_j = 110 \text{ }^\circ\text{C}$					0.75	
dv/dt^*	$T_j = 110 \text{ }^\circ\text{C}$ Linear Slope up to $V_D = 67\% V_{DRM}$	Gate Open				10		V/ μs
$(dv/dt)_c^*$	$T_j = 40 \text{ }^\circ\text{C}$ $(di/dt)_c = 0.4 \text{ A/ms}$	$V_D = V_{DRM}$	$I_T = 1.4 \text{ A}$			1		V/ μs
t_{gt}	$T_j = 25 \text{ }^\circ\text{C}$ $I_G = 100 \text{ mA}$	$V_D = V_{DRM}$ $di_G/dt = 1 \text{ A}/\mu\text{s}$	$I_T = 1.4 \text{ A}$	I-II-III-IV		3		μs

* For either polarity of electrode A_2 voltage with reference to electrode A_1 .

PACKAGE MECHANICAL DATA

TL Plastic

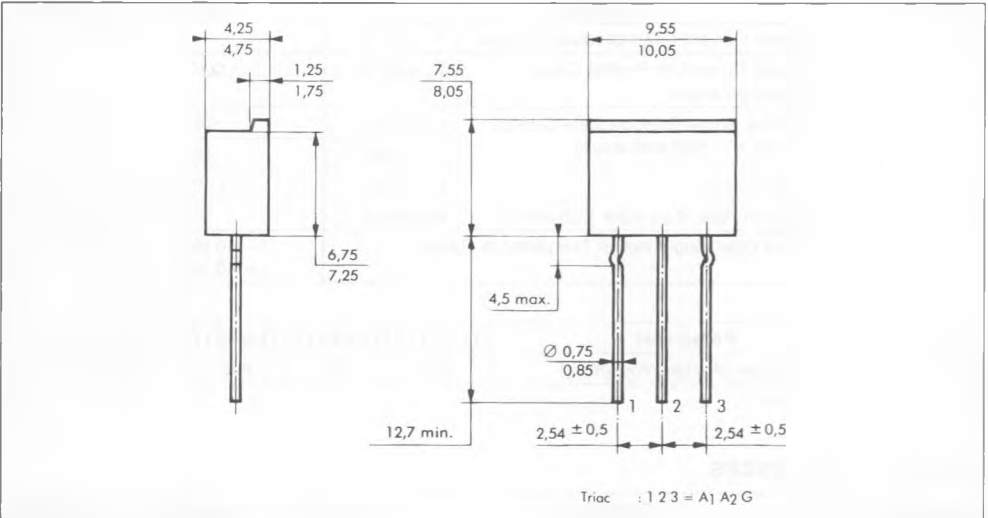

Cooling method : by convection (method A)
 Marking : type number
 Weight : 0.8 g.

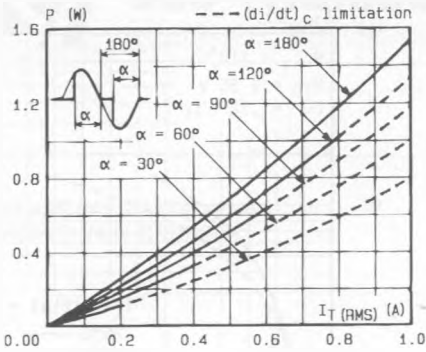

Fig. 1 - Maximum mean power dissipation versus RMS on-state current ($F = 60 \text{ Hz}$).

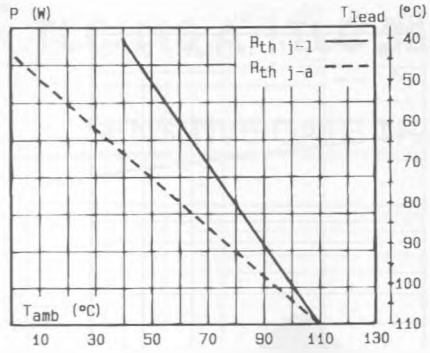

Fig. 2 - Correlation between maximum mean power dissipation and maximum allowable temperatures (T_{amb} and T_{lead}). resistances heatsink + contact.

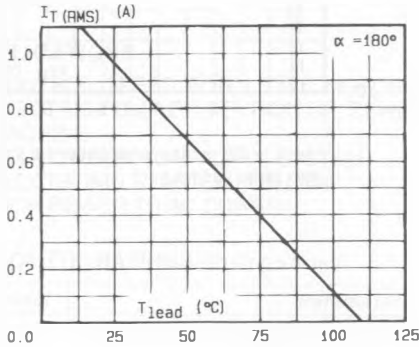

Fig. 3 - RMS on-state current versus lead temperature.

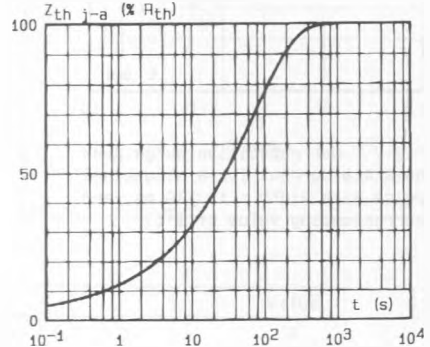

Fig. 4 - Thermal transient impedance junction to ambient versus pulse duration.

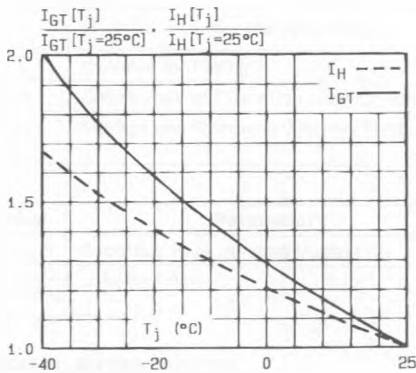

Fig. 5 - Relative variation of gate trigger current and holding current versus junction temperature.

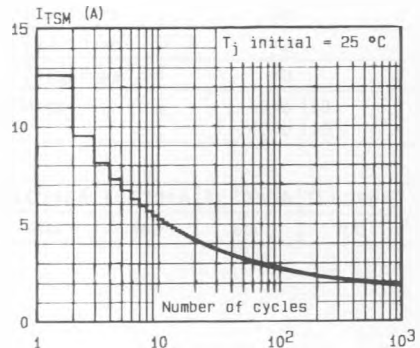

Fig. 6 - Non repetitive surge peak on state current versus number of cycles.

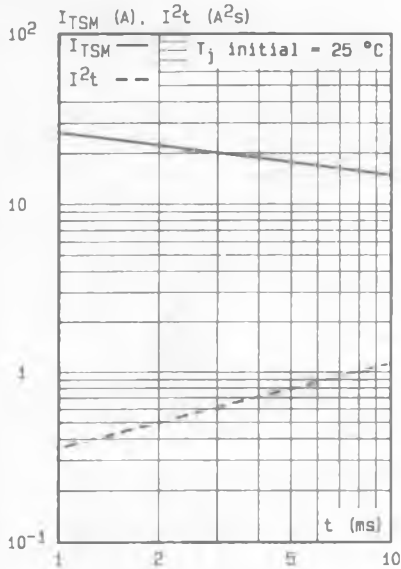

Fig.7 - Non repetitive surge peak on-state current for a sinusoidal pulse with width : $t \leq 10$ ms, and corresponding value of I^2t .

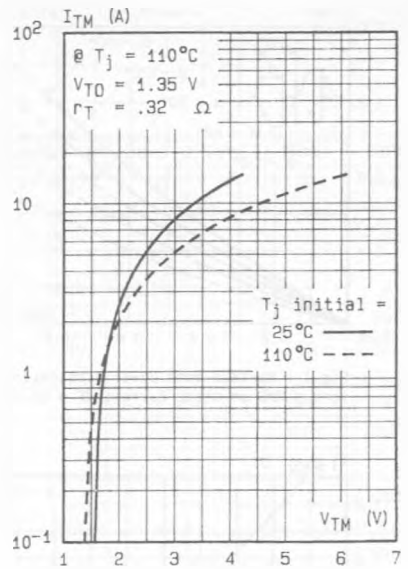

Fig.8 - On-state characteristics (maximum values).