

**ALTERNISTORS**

- $(di/dt)_c > 88 \text{ A/ms}$  (400 Hz)
- INSULATING VOLTAGE : 2500  $V_{RMS}$   
( $t \leq 1 \text{ mn} - F = 50 \text{ Hz}$ )
- UL RECOGNIZED (EB1734)

**APPLICATIONS**

- POWER CONTROL ON INDUCTIVE LOAD  
(motor, transformer...)
- HIGH FREQUENCY OR HIGH  $(di/dt)_c$  LEVEL  
CIRCUITS

**DESCRIPTION**

New range of solid state AC - switches with very high commutating capability.

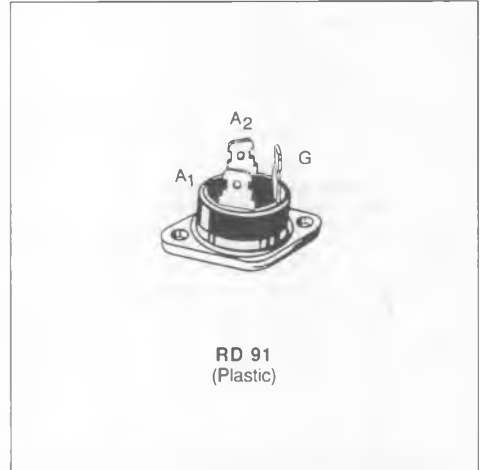
**ABSOLUTE RATINGS** (limiting values)

Symbol	Parameter	Value	Unit
$I_{T(RMS)}$	RMS on-state Current (360° conduction angle)	$T_C = 80 \text{ }^\circ\text{C}$ 25	A
$I_{TSM}$	Non Repetitive Surge Peak on-state Current	$t = 10 \text{ ms}$ 230	A
		$t = 8.3 \text{ ms}$ 250	
		$t = 2.5 \text{ ms}$ 390	
$I^2t$	$I^2t$ Value for Fusing	$t = 10 \text{ ms}$ 265	$\text{A}^2\text{s}$
$di/dt$	Critical Rate of Rise of on-state Current (1)	100	$\text{A}/\mu\text{s}$
$T_{stg}$ $T_j$	Storage and Operating Junction Temperature Range	- 40 to 125 - 40 to 125	$^\circ\text{C}$ $^\circ\text{C}$

Symbol	Parameter	TODV							Unit
		125	225	425	625	825	1025	1225	
$V_{DRM}$	Repetitive Peak off-state Voltage (2)	100	200	400	600	800	1000	1200	V

(1)  $I_G = 1.5 \text{ A}$      $di_c/dt = 1 \text{ A}/\mu\text{s}$

(2)  $T_j = 125 \text{ }^\circ\text{C}$ .

**THERMAL RESISTANCES**

Symbol	Parameter	Value	Unit
$R_{th(c-h)}$	Contact (case-heatsink) with Grease	0.1	$^\circ\text{C}/\text{W}$
$R_{th(j-c)} \text{ DC}$	Junction to Case for DC	1.6	$^\circ\text{C}/\text{W}$
$R_{th(j-c)} \text{ AC}$	Junction to Case for 360° Conduction Angle ( $F = 50 \text{ Hz}$ )	1.2	$^\circ\text{C}/\text{W}$

**GATE CHARACTERISTICS** (maximum values)

$P_{GM} = 40 \text{ W}$  ( $t_p = 10 \mu\text{s}$ )       $I_{GM} = 8 \text{ A}$  ( $t_p = 10 \mu\text{s}$ )  
 $P_{G(AV)} = 1 \text{ W}$        $V_{GM} = 16 \text{ V}$  ( $t_p = 10 \mu\text{s}$ )

**ELECTRICAL CHARACTERISTICS**

Symbol	Test Conditions			Quadrants	Min.	Typ.	Max.	Unit
$I_{GT}$	$T_J = 25 \text{ }^\circ\text{C}$ Pulse Duration > 20 $\mu\text{s}$	$V_D = 12 \text{ V}$	$R_L = 33 \text{ } \Omega$	I-II-III			150	mA
$V_{GT}$	$T_J = 25 \text{ }^\circ\text{C}$ Pulse Duration > 20 $\mu\text{s}$	$V_D = 12 \text{ V}$	$R_L = 33 \text{ } \Omega$	I-II-III			1.5	V
$V_{GD}$	$T_J = 125 \text{ }^\circ\text{C}$	$V_D = V_{DRM}$	$R_L = 3.3 \text{ k}\Omega$	I-II-III	0.2			V
$I_H^*$	$T_J = 25 \text{ }^\circ\text{C}$	$I_T = 500 \text{ mA}$	Gate Open			50		mA
$I_L$	$T_J = 25 \text{ }^\circ\text{C}$ Pulse Duration > 20 $\mu\text{s}$	$V_D = 12 \text{ V}$	$I_G = 300 \text{ mA}$	I-III		50		mA
				II		100		
$V_{TM}^*$	$T_J = 25 \text{ }^\circ\text{C}$	$I_{TM} = 35 \text{ A}$	$t_p = 10 \text{ ms}$				1.8	V
$I_{DRM}^*$	$T_J = 125 \text{ }^\circ\text{C}$	$V_{DRM}$ Specified					8	mA
$dv/dt^*$	$T_J = 125 \text{ }^\circ\text{C}$ Linear Slope up to $V_D = 67\% V_{DRM}$	Gate Open	$V_{DRM} \leq 800 \text{ V}$		500			V/ $\mu\text{s}$
			$V_{DRM} \geq 1000 \text{ V}$		250			
$(di/dt)_c^*$	$T_C = 80 \text{ }^\circ\text{C}$ $I_T = 35 \text{ A}$	$V_D = V_{DRM}$	$(dv/dt)_c = 200 \text{ V}/\mu\text{s}$		20			A/ms
			$(dv/dt)_c = 10 \text{ V}/\mu\text{s}$		88			
$t_{gi}$	$T_J = 25 \text{ }^\circ\text{C}$ $I_G = 0.5 \text{ A}$	$V_D = V_{DRM}$ $di_G/dt = 3.5 \text{ A}/\mu\text{s}$	$I_T = 35 \text{ A}$	I-II-III		2.5		$\mu\text{s}$

\* For either polarity of electrode  $A_2$  voltage with reference to electrode  $A_1$ .

**PACKAGE MECHANICAL DATA : RD 91 Plastic**

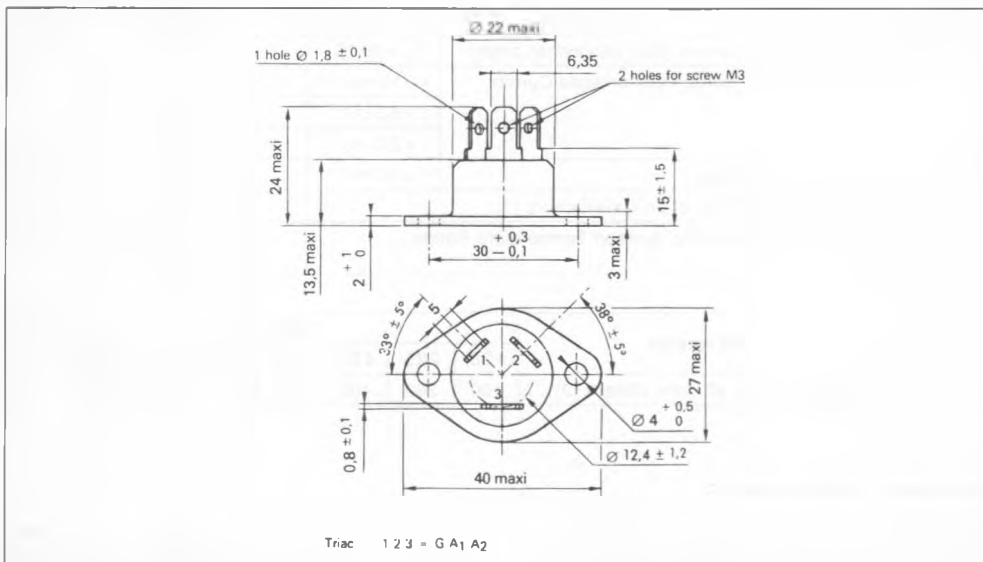

Cooling method : by conduction (method C)

Marking : type number

Weight : 15 g

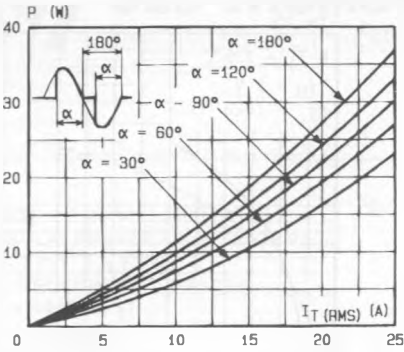

Fig.1 - Maximum mean power dissipation versus RMS on-state current.

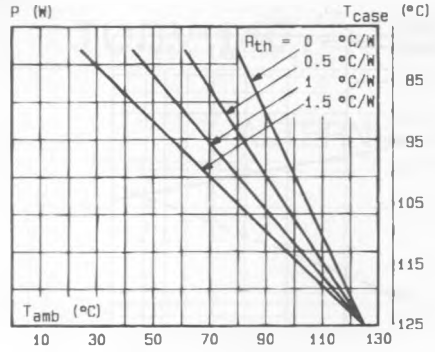

Fig.2 - Correlation between maximum mean power dissipation and maximum allowable temperatures ( $T_{amb}$  and  $T_{case}$ ) for different thermal resistances heatsink + contact.

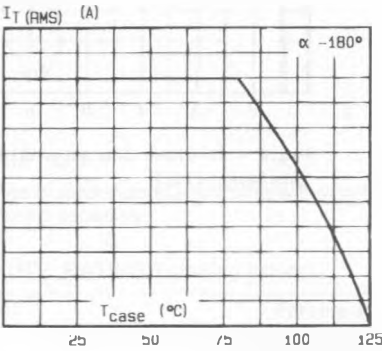

Fig.3 - RMS on-state current versus case temperature.

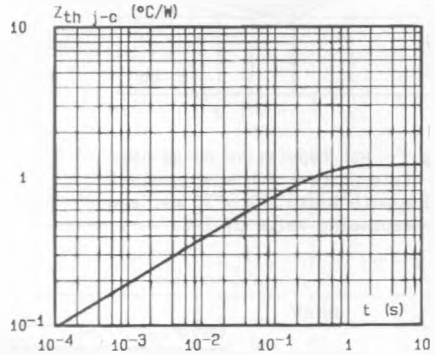

Fig.4 - Thermal transient impedance junction to case versus pulse duration.

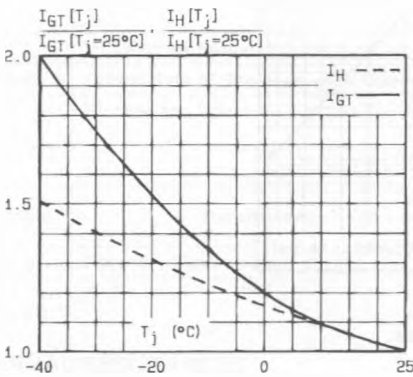

Fig 5 - Relative variation of gate trigger current and holding current versus junction temperature.

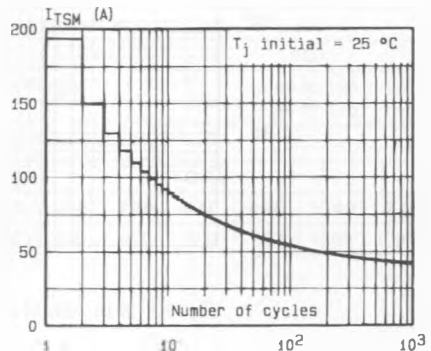

Fig 6 - Non repetitive surge peak on-state current versus number of cycles.

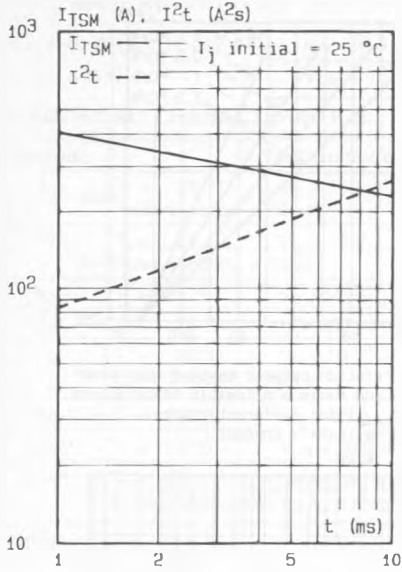

Fig.7 - Non repetitive surge peak on-state current for a sinusoidal pulse with width :  $t \leq 10$  ms, and corresponding value of  $I^2t$ .

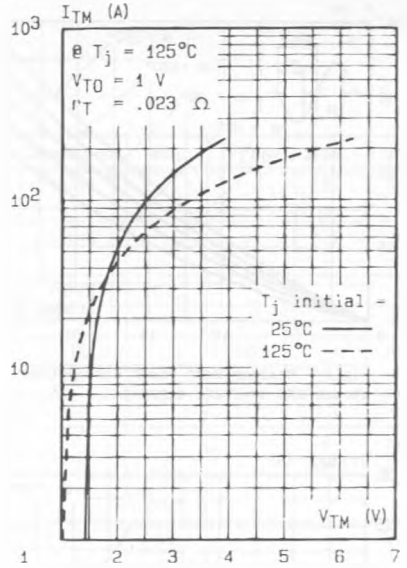

Fig.8 - On-state characteristics (maximum values).

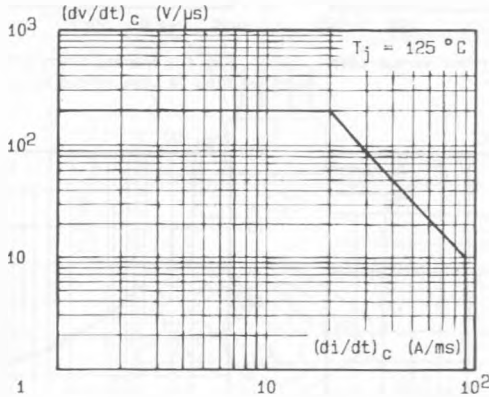

Fig.9 - Safe operating area.