



ALTERNISTORS

- $(di/dt)_c > 88 \text{ A/ms}$ (400 Hz)
- INSULATING VOLTAGE : 2500 V_{RMS}
($t \leq 1 \text{ mn}$ - $F = 50 \text{ Hz}$)
- UL RECOGNIZED (EB81734)

APPLICATIONS

- POWER CONTROL ON INDUCTIVE LOAD
(motor, transformer...)
- HIGH FREQUENCY OR HIGH $(di/dt)_c$ LEVEL
CIRCUITS

DESCRIPTION

New range of solid state AC - switches with very high commutating capability.



ABSOLUTE RATINGS (limiting values)

Symbol	Parameter		Value	Unit
$I_{T(RMS)}$	RMS on-state Current (360° conduction angle)	$T_C = 75 \text{ }^\circ\text{C}$	25	A
I_{TSM}	Non Repetitive Surge Peak on-state Current	$t = 10 \text{ ms}$	230	A
		$t = 8.3 \text{ ms}$	250	
		$t = 2.5 \text{ ms}$	390	
I^2t	I^2t Value for Fusing	$t = 10 \text{ ms}$	265	A^2s
di/dt	Critical Rate of Rise of on-state Current (1)		100	$\text{A}/\mu\text{s}$
T_{stg} T_j	Storage and Operating Junction Temperature Range		- 40 to 125 - 40 to 125	$^\circ\text{C}$ $^\circ\text{C}$

Symbol	Parameter	TPDV							Unit
		125	225	425	625	825	1025	1225	
V_{DRM}	Repetitive Peak off-state Voltage (2)	100	200	400	600	800	1000	1200	V

(1) $I_G = 1.5 \text{ A}$ $di/dt = 1 \text{ A}/\mu\text{s}$

(2) $T_j = 125 \text{ }^\circ\text{C}$.

THERMAL RESISTANCES

Symbol	Parameter	Value	Unit
$R_{th(j-a)}$	Junction to Ambient	50	$^\circ\text{C}/\text{W}$
$R_{th(c-h)}$	Contact (case-heatsink) with Grease	0.15	$^\circ\text{C}/\text{W}$
$R_{th(j-c)} \text{ DC}$	Junction to Case for DC	2.09	$^\circ\text{C}/\text{W}$
$R_{th(j-c)} \text{ AC}$	Junction to Case for 360° Conduction Angle ($F = 50 \text{ Hz}$)	1.56	$^\circ\text{C}/\text{W}$

GATE CHARACTERISTICS (maximum values)

$P_{GM} = 40 \text{ W}$ ($t_p = 10 \mu\text{s}$) $I_{GM} = 8 \text{ A}$ ($t_p = 10 \mu\text{s}$)
 $P_G(AV) = 1 \text{ W}$ $V_{GM} = 16 \text{ V}$ ($t_p = 10 \mu\text{s}$)

ELECTRICAL CHARACTERISTICS

Symbol	Test Conditions	Quadrants	Min.	Typ.	Max.	Unit
I_{GT}	$T_j = 25 \text{ }^\circ\text{C}$ $V_D = 12 \text{ V}$ $R_L = 33 \text{ } \Omega$ Pulse Duration $> 20 \mu\text{s}$	I-II-III			150	mA
V_{GT}	$T_j = 25 \text{ }^\circ\text{C}$ $V_D = 12 \text{ V}$ $R_L = 33 \text{ } \Omega$ Pulse Duration $> 20 \mu\text{s}$	I-II-III			1.5	V
V_{GD}	$T_j = 125 \text{ }^\circ\text{C}$ $V_D = V_{DRM}$ $R_L = 3.3 \text{ k}\Omega$	I-II-III	0.2			V
I_H^*	$T_j = 25 \text{ }^\circ\text{C}$ $I_T = 500 \text{ mA}$ Gate Open			50		mA
I_L	$T_j = 25 \text{ }^\circ\text{C}$ $V_D = 12 \text{ V}$ $I_G = 300 \text{ mA}$ Pulse Duration $> 20 \mu\text{s}$	I-III		50		mA
		II		100		
V_{TM}^*	$T_j = 25 \text{ }^\circ\text{C}$ $I_{TM} = 35 \text{ A}$ $t_p = 10 \text{ ms}$				1.8	V
I_{DRM}^*	$T_j = 125 \text{ }^\circ\text{C}$ V_{DRM} Specified				8	mA
dv/dt^*	$T_j = 125 \text{ }^\circ\text{C}$ Gate Open Linear Slope upto $V_D = 67\% V_{DRM}$	$V_{DRM} \leq 800 \text{ V}$		500		$V/\mu\text{s}$
		$V_{DRM} \geq 1000 \text{ V}$		250		
$(di/dt)_c^*$	$T_C = 75 \text{ }^\circ\text{C}$ $V_D = V_{DRM}$ $I_T = 35 \text{ A}$	$(dv/dt)_c = 200 \text{ V}/\mu\text{s}$		20		A/ms
		$(dv/dt)_c = 10 \text{ V}/\mu\text{s}$		88		
t_{gt}	$T_j = 25 \text{ }^\circ\text{C}$ $V_D = V_{DRM}$ $I_T = 35 \text{ A}$ $I_G = 0.5 \text{ A}$ $di_G/dt = 3.5 \text{ A}/\mu\text{s}$	I-II-III		2.5		μs

* For either polarity of electrode A₂ voltage with reference to electrode A₁.

PACKAGE MECHANICAL DATA : TOP 3 Plastic

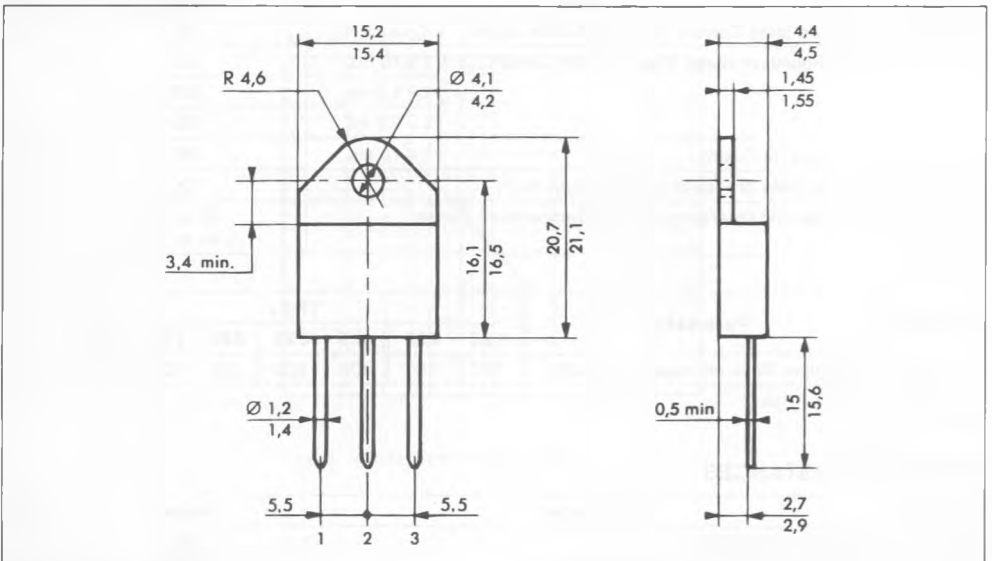

Cooling method : by conduction (method C)
 Marking : type number
 Weight : 5 g

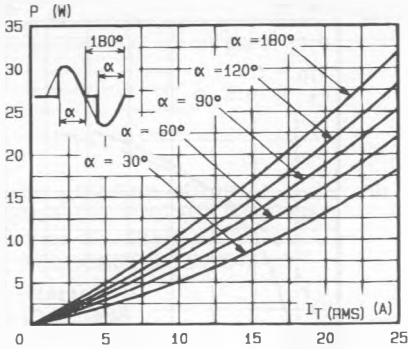

Fig.1 - Maximum mean power dissipation versus RMS on-state current.

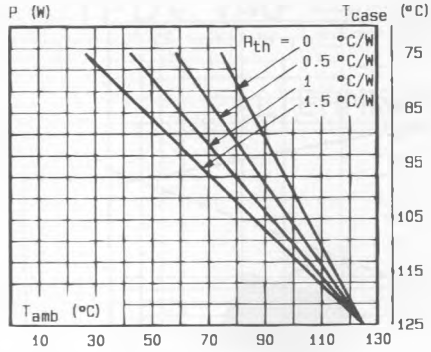

Fig.2 - Correlation between maximum mean power dissipation and maximum allowable temperatures (T_{amb} and T_{case}) for different thermal resistances heatsink + contact.

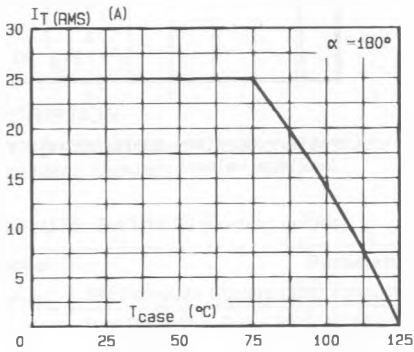

Fig.3 - RMS on-state current versus case temperature.

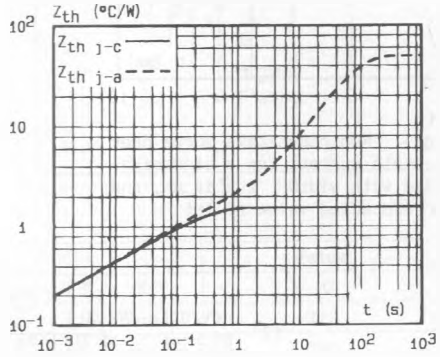

Fig.4 - Thermal transient impedance junction to case and junction to ambient versus pulse duration.

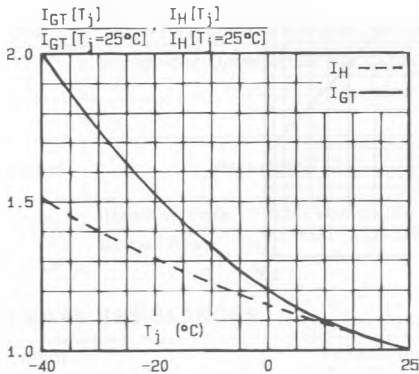

Fig.5 - Relative variation of gate trigger current and holding current versus junction temperature.

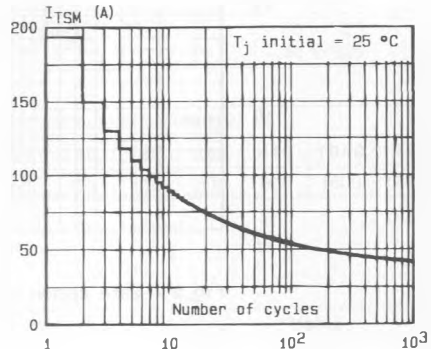

Fig.6 - Non repetitive surge peak on-state current versus number of cycles.

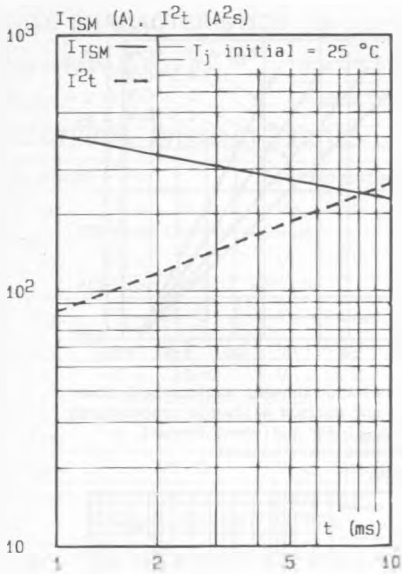

Fig.7 - Non repetitive surge peak on-state current for a sinusoidal pulse with width : $t \leq 10$ ms, and corresponding value of I^2t .

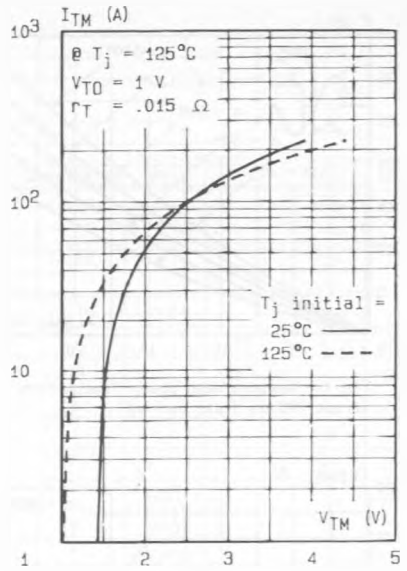

Fig.8 - Un-state characteristics (maximum values).

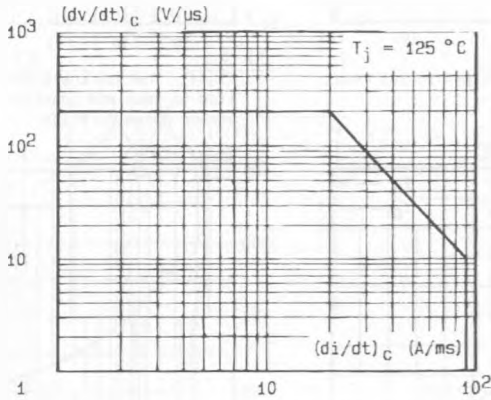

Fig.9 - Safe operating area.