

**ALTERNISTORS**

- $(di/dt)_c > 42.5$  A/ms (400 Hz)
- INSULATING VOLTAGE : 2500 V<sub>RMS</sub>  
( $t \leq 1$  mn - F = 50 Hz)
- UL RECOGNIZED (E81734)

**APPLICATIONS**

- POWER CONTROL ON INDUCTIVE LOAD  
(motor, transformer...)
- HIGH FREQUENCY OR HIGH  $(di/dt)_c$  LEVEL  
CIRCUITS

**DESCRIPTION**

New range of solid state AC - switches with very high commutating capability.

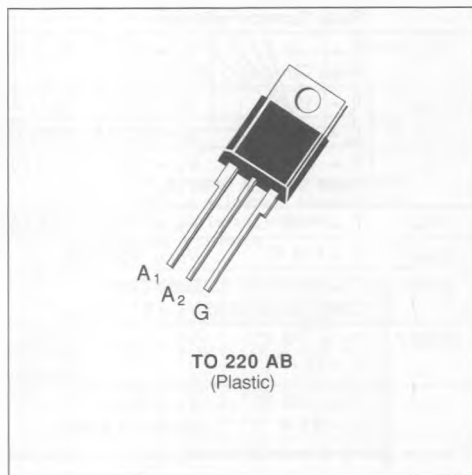
**ABSOLUTE RATINGS** (limiting values)

Symbol	Parameter		Value	Unit
$I_{T(RMS)}$	RMS on-state Current (360° conduction angle)	$T_C = 75^\circ\text{C}$	12	A
$I_{TSM}$	Non Repetitive Surge Peak on-state Current	$t = 10$ ms	120	A
		$t = 8.3$ ms	125	
		$t = 2.5$ ms	170	
$I^2t$	$I^2t$ Value for Fusing	$t = 10$ ms	72	A <sup>2</sup> s
$di/dt$	Critical Rate of Rise of on-state Current (1)		100	A/ $\mu$ s
$T_{stg}$ $T_j$	Storage and Operating Junction Temperature Range		- 40 to 150 - 40 to 110	$^\circ\text{C}$ $^\circ\text{C}$

Symbol	Parameter	TXDV				Unit
		212	412	612	812	
$V_{DRM}$	Repetitive Peak off-state Voltage (2)	200	400	600	800	V

- (1)  $I_G = 1$  A  $di/dt = 1$  A/ $\mu$ s  
 (2)  $T_j = 110^\circ\text{C}$ .

**THERMAL RESISTANCES**

Symbol	Parameter	Value	Unit
$R_{th(j-a)}$	Junction to Ambient	60	$^\circ\text{C/W}$
$R_{th(j-c)}$ DC	Junction to Case for DC	2.5	$^\circ\text{C/W}$
$R_{th(j-c)}$ AC	Junction to Case for 360° Conduction Angle (F = 50 Hz)	1.85	$^\circ\text{C/W}$

**GATE CHARACTERISTICS** (maximum values)

$P_{GM} = 40 \text{ W}$  ( $t_p = 10 \mu\text{s}$ )       $I_{GM} = 4 \text{ A}$  ( $t_p = 10 \mu\text{s}$ )  
 $P_{G(AV)} = 1 \text{ W}$        $V_{GM} = 16 \text{ V}$  ( $t_p = 10 \mu\text{s}$ )

**ELECTRICAL CHARACTERISTICS**

Symbol	Test Conditions	Quadrants	Min.	Typ.	Max.	Unit
$I_{GT}$	$T_j = 25 \text{ }^\circ\text{C}$ $V_D = 12 \text{ V}$ $R_L = 33 \text{ } \Omega$ Pulse Duration $> 20 \mu\text{s}$	I-II-III			100	mA
$V_{GT}$	$T_j = 25 \text{ }^\circ\text{C}$ $V_D = 12 \text{ V}$ $R_L = 33 \text{ } \Omega$ Pulse Duration $> 20 \mu\text{s}$	I-II-III			1.5	V
$V_{GD}$	$T_j = 110 \text{ }^\circ\text{C}$ $V_D = V_{DRM}$ $R_L = 3.3 \text{ k}\Omega$	I-II-III	0.2			V
$I_H^*$	$T_j = 25 \text{ }^\circ\text{C}$ $I_T = 500 \text{ mA}$ Gate Open				100	mA
$I_L$	$T_j = 25 \text{ }^\circ\text{C}$ $V_D = 12 \text{ V}$ $I_G = 200 \text{ mA}$ Pulse Duration $> 20 \mu\text{s}$	I-III		100		mA
		II		200		
$V_{TM}^*$	$T_j = 25 \text{ }^\circ\text{C}$ $I_{TM} = 17 \text{ A}$ $t_p = 10 \text{ ms}$				1.95	V
$I_{DRM}^*$	$T_j = 110 \text{ }^\circ\text{C}$ $V_{DRM}$ Specified				2	mA
$dv/dt^*$	$T_j = 110 \text{ }^\circ\text{C}$ Gate Open Linear Slope up to $V_D = 67 \% V_{DRM}$		500			V/ $\mu\text{s}$
$(di/dt)_c^*$	$T_C = 75 \text{ }^\circ\text{C}$ $V_D = V_{DRM}$ $I_T = 17 \text{ A}$	$(dv/dt)_c = 200 \text{ V}/\mu\text{s}$	10			A/ms
		$(dv/dt)_c = 10 \text{ V}/\mu\text{s}$	42.5			
$t_{gI}$	$T_j = 25 \text{ }^\circ\text{C}$ $V_D = V_{DRM}$ $I_T = 17 \text{ A}$ $I_G = 0.5 \text{ A}$ $di_G/dt = 3.5 \text{ A}/\mu\text{s}$	I-II-III		2.5		$\mu\text{s}$

\* For either polarity of electrode  $A_2$  voltage with reference to electrode  $A_1$ .

**PACKAGE MECHANICAL DATA : TO 220 AB Plastic**

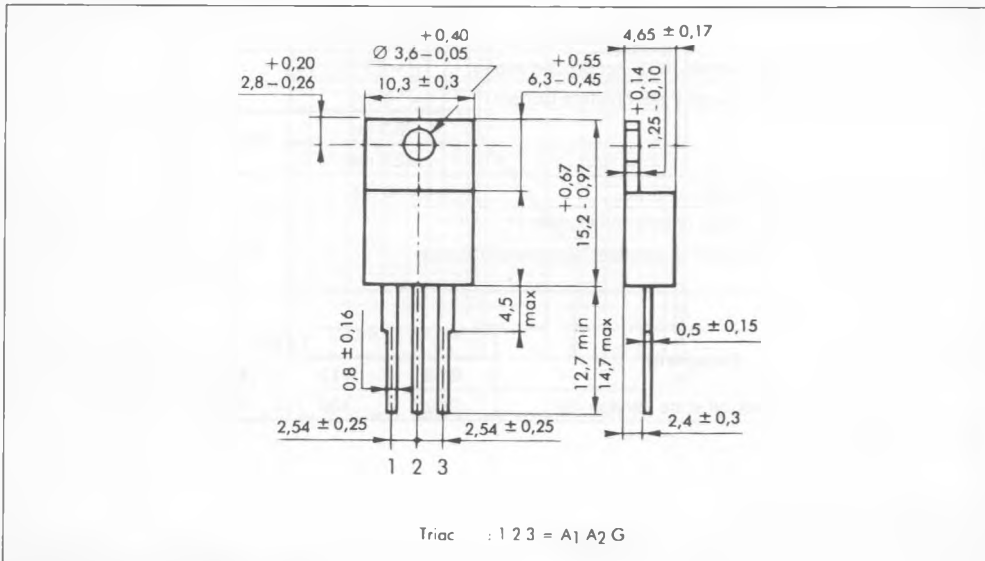

Cooling method : by conduction (method C)  
 Marking : type number  
 Weight : 2 g

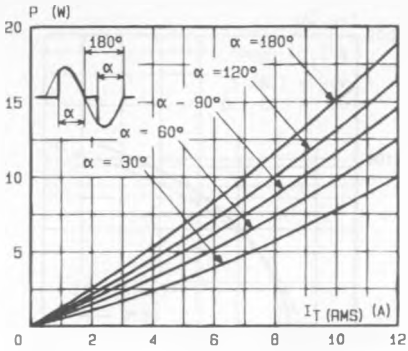

Fig. 1 - Maximum mean power dissipation versus RMS on-state current

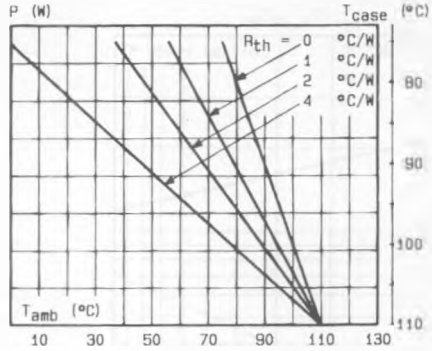

Fig. 2 - Correlation between maximum mean power dissipation and maximum allowable temperatures ( $T_{amb}$  and  $T_{case}$ ) for different thermal resistances heatsink + contact.

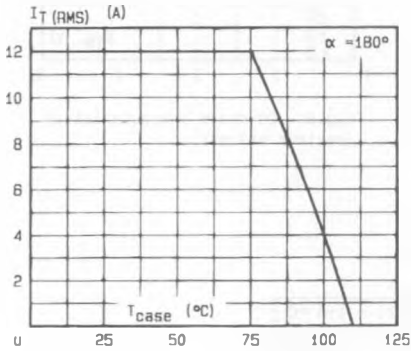

Fig. 3 - RMS on-state current versus case temperature.

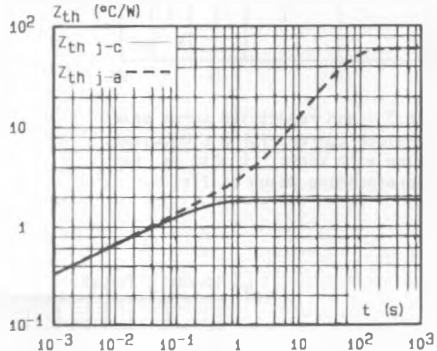

Fig. 4 - Thermal transient impedance junction to case and junction to ambient versus pulse duration.

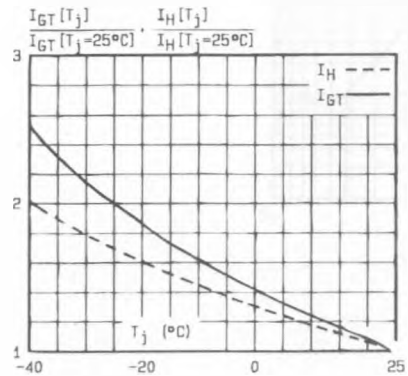

Fig. 5 - Relative variation of gate trigger current and holding current versus junction temperature.

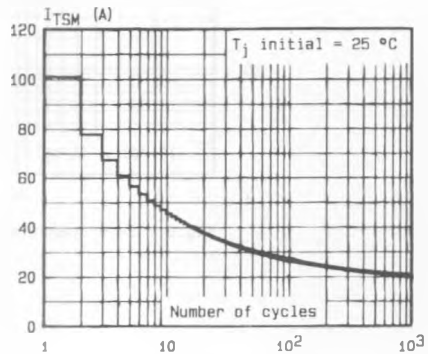

Fig. 6 - Non repetitive surge peak on-state current versus number of cycles.

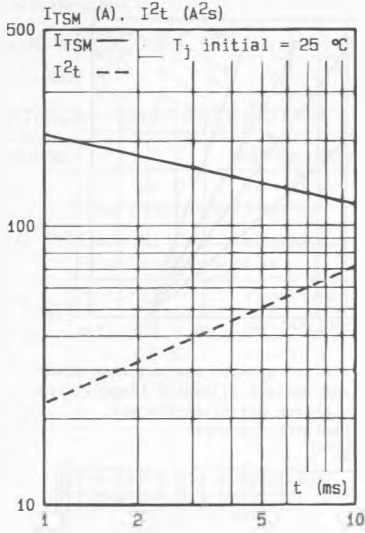

Fig.7 - Non repetitive surge peak on-state current for a sinusoidal pulse with width :  $t \leq 10$  ms, and corresponding value of  $I^2t$ .

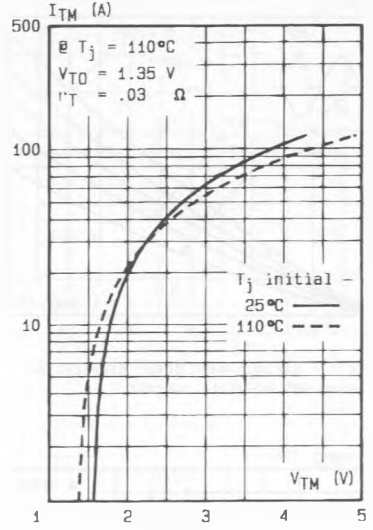

Fig.8 - On-state characteristics (maximum values).

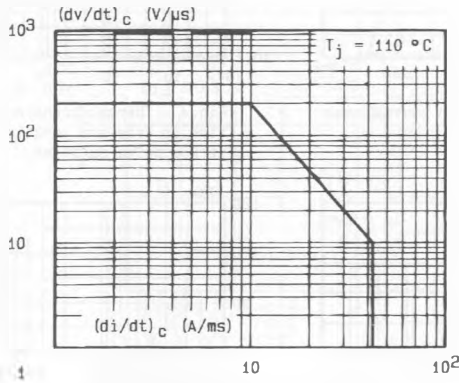

Fig.9 - Safe operating area.