

MT - 8660

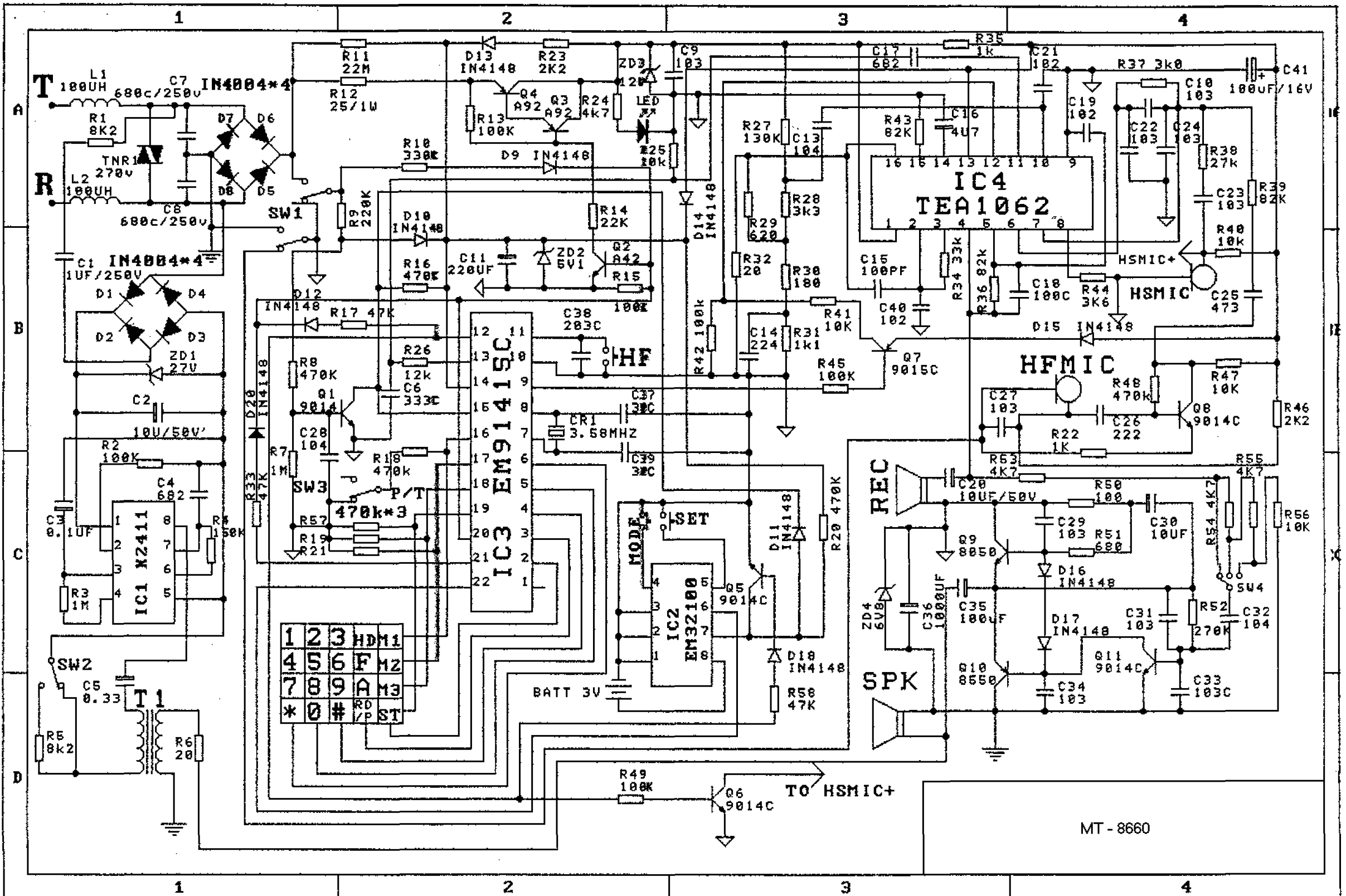

MT - 8660